

**Σ<sup>+</sup> Series**

**Programmable DC Power Supplies  
200W/400W/600W/800W in 2U  
Built-in USB, RS-232 & RS-485 Interface**

**Optional Interface: LAN  
IEEE488.2 SCPI (GPIB) Multi-Drop  
Isolated Analog Programming**



**TDK-Lambda**

## Features Include:

- High Power Density 200W/400W/600W/800W in 2U: 3.5 Inch (89mm) height
- Wide Range Input (85-265Vac continuous)
- Active Power Factor Correction (0.99 typical)
- Output Voltage up to 650V, Current up to 5A
- Constant Voltage (CV)/(CC) Constant Current auto-crossover
- Built-in RS-232/RS-485 Interface Standard
- Global Commands for Serial RS-232/RS-485 Interface
- Auto-Re-Start / Safe-Start: user selectable
- Last-Setting Memory
- High Resolution 16 bit ADCs & DACs
- Low Ripple & Noise
- Front Panel Lock selectable from Front Panel or Software
- Reliable Encoders for Voltage and Current adjustment
- Parallel Operation with Active Current Sharing, for up to six identical units
- Advanced Parallel Master / Slave. Total Current is programmed and measured via the Master
- External Analog Programming and Monitoring (user selectable 0-5V & 0-10V)
- Reliable Modular and SMT Design
- 19" Rack Mount Capability for ATE and OEM applications
- Optional Interfaces
  - Isolated Analog Programming and Monitoring Interface (0-5V/0-10V & 4-20mA)
  - IEEE 488.2 SCPI (GPIB) Multi-Drop
  - LAN
  - LabView® and LabWindows® drivers
- Arbitrary functions for:
  - Automotive or laser simulation / 4 Pre-Programmed Functions
- Fast Command Processing Time
- Output Sequencing
- Four-cell Memory Settings
- User Programmable Signal Pins
- Five Year Warranty
- Worldwide Safety Agency Approvals; CE Mark for LVD and EMC regulations



## Front Panel Description



1. AC ON/OFF Switch
2. Air Intake allows zero stacking for maximum system flexibility and power density.\*
3. Reliable encoder controls Output Voltage and power supply setting.
4. Volt Display shows Output Voltage and directly displays and power supply settings.
5. Reliable encoder controls Output Current, and power supply setting.
6. Current Display shows Output Current and power supply setting.
7. Function/Status LEDs:
  - Alarm
  - Fine Control
  - Preview Settings
  - Foldback Mode
  - Remote Mode
  - Output On
8. Pushbuttons allow flexible user configuration
  - Coarse and Fine adjustment of Output Voltage/Current and Advanced Parallel Master or Slave
  - Preview settings and set Voltage/Current with Output OFF, Front Panel Lockout
  - Set OVP, UVP, UVL Limits
  - Set Current Foldback
  - Local/Remote Mode and select Address and Baud Rate
  - Output ON/OFF and Auto-Start/Safe-Start Mode
  - Menu
9. Optional front panel insulated output sockets (Ø 4mm) for modules up to 650V: 5A Max

\* Zero stacking - side-by-side mounting of 6 units in a 19" Rack

## Rear Panel Description

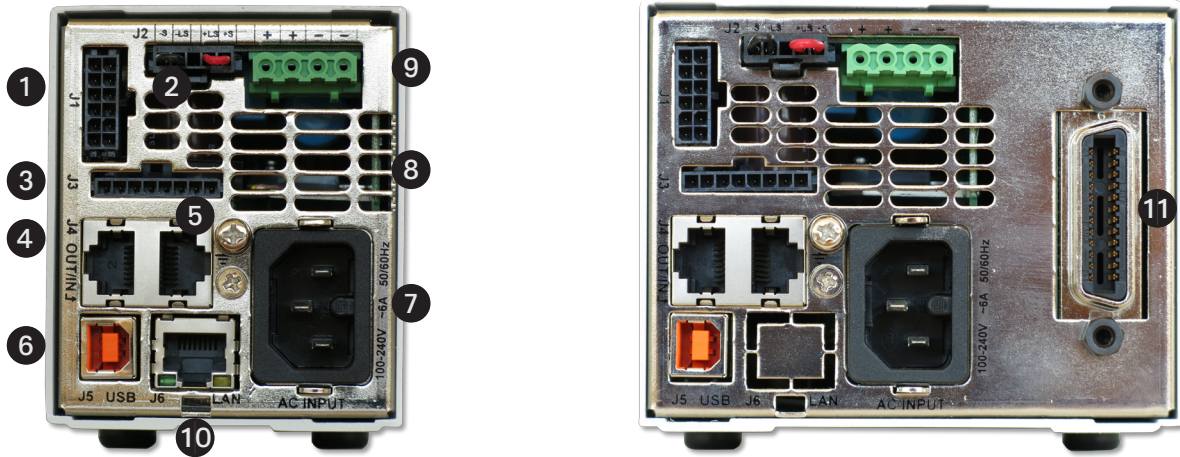

1. Connector allows (Non-isolated) Analog Program and Monitor and other functions.
2. Remote/Local Output Voltage Sense Connections.
3. Signal Connector
4. RS-232/RS-485 INPUT Remote Serial Programming.
5. RS-485 OUTPUT to other Z<sup>+</sup> Power Supplies.
6. USB Interface
7. Wide-Range Input 85-265VAC continuous, 47/63Hz with Active Power Factor Correction (0.99 typical)  
AC Input Connector: IEC320 -C16.
8. Exhaust air exits at the back. Allows vertical stacking of units without any separation between units
9. Output Connections:  
MALE CONNECTOR (IC 2,5/ 4-G-5,08 , PHOENIX CONTACT).  
FEMALE PLUG (IC 2,5/4-ST-5,08, PHOENIX CONTACT).
10. Optional Interface Position for LAN Interface.
11. Optional Interface Position for GPIB Interface (shown) or Isolated Analog Interface.

## Power Benchtop Parallel and Series Configurations

### Benchtop Power Supply

Parallel operation - Master/Slave:

Active current sharing allows up to six identical units to be connected in an auto-parallel configuration for six times the output power.

In Advanced Parallel Master/Slave Mode, total current is programmed and reported by the Master, Up to six supplies act as one.



### Series operation

Up to two units may be connected in series to increase the output voltage or to provide bipolar output.

### Remote Programming via Built-in USB, RS-232 & RS-485 Interface

Standard Serial Interface allows daisy chain control of up to 31 power supplies on the same bus with built-in RS-232 & RS-485 Interface.

### Optional Interface:

### LAN & IEEE488.2 SCPI (GPIB)

#### Multi-Drop

Allows LAN/IEEE Master to control up to 31 slaves over RS-485 daisy-chain

Only the Master needs be equipped with LAN/IEEE Interface

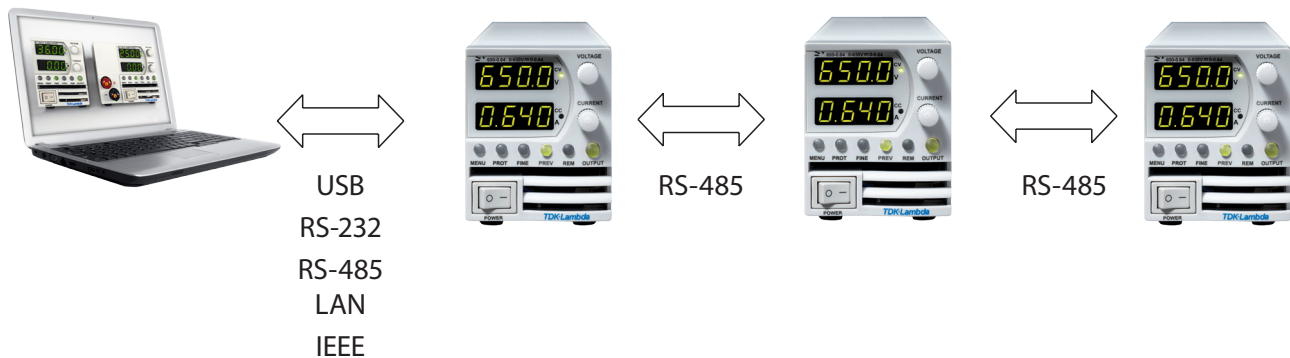

**Applications**

Z<sup>+</sup> series power supplies have been designed to meet the demands of a wide variety of applications.

**Test and Measurement**

Built-in Last-Setting memory based on Flash Memory no battery or capacitor backup. Simplifies test design and requirements.

Built-in RS-232/RS-485 gives maximum system flexibility along with 0-5V and 0-10V, selectable analog programming.

Wide range of available inputs allows testing of many different devices.

**Semiconductor Burn-in**

Safe-Start mode ENABLED - to re-start at Output OFF to protect load.

Wide range input (85-265Vac) with Active Power Factor correction rides through input transients easily.

**Component Test**

High power density, zero stacking and single wire parallel operation, give maximum system flexibility.

**Laser Diode**

OVP is directly set on Voltage Display, assuring accurate protection settings.

Fast Constant Current response, no over shoot. Current Limit Fold Back assures load is protected from current surges.

**Heater Supplies**

Smooth, reliable encoders enhance front panel control.

Remote analog programming is user selectable 0-5V or 0-10V.

**RF Amplifiers and Magnets**

Robust design assures stable operation under a wide variety of loads. High linearity in Voltage & Current mode.

**Z<sup>+</sup> Series Sequence Programming Applications:**

MILITARY STANDARD 704E Testing

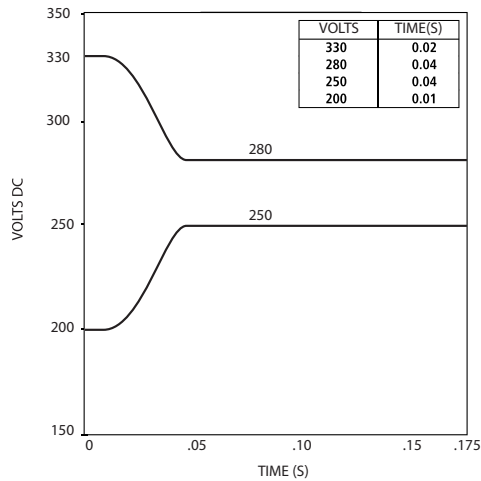

Reset behaviour at voltage drop

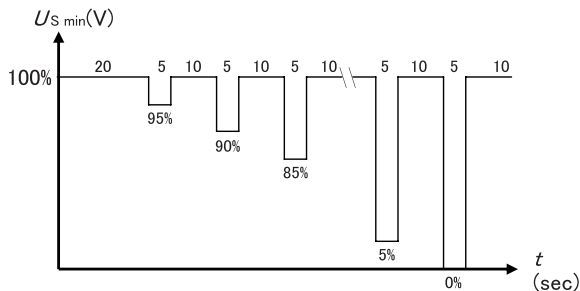

Discontinuities in supply voltage  
Momentary drop in supply voltage

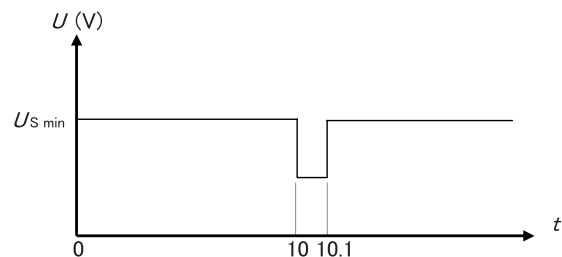

**Options: (200W/400W/600W/800W)**

**Front Panel insulated Output sockets**

Up to 650V Output Module

P/N: Z\_\_ - \_\_ - L2



Optional front panel insulated output sockets (Ø 4mm) for modules up to 650V: 5A Max - L2

**Z+ Assemblies**

Dual Output Housing (for 105mm) 200W/400W/600W/800W

Triple Output Housing (for 70mm) 200W/400W/600W/800W

P/N: Z-NL200 (same p/n for both Dual & Triple Output Housing)w



**19" Rack Mounted to 4.8kW**

Six units (70mm) can be assembled into 19-Inch rack/2U high

Four units (105mm) can be assembled into 19-Inch rack/2U high to meet your configuration requirements.

In cases where the entire rack is not occupied with power units,

P/N: Z-BP for 70mm, P/N: Z-WBP for 105mm blank panels can be installed:

**P/N: Z-NL100**



**Power Modules Table**

Module Type	200W	400W	600W	800W
0~160V	1.3A	2.6A	4A	5A
0~320V	0.65A	1.3A	2A	2.5A
0~650V	0.32A	0.64A	1A	1.25A
19" rack width	1/6 width	1/6 width	1/6 width	1/6 width
19" rack width	1/4 width	1/4 width	1/4 width	1/4 width



1/6 width



1/4 width

**Programming Options (Factory Installed)**

**Digital Programming via IEEE Interface**

P/N: IEEE

- IEEE 488.2 SCPI Compliant
- Program Voltage
- Measure Voltage
- Over Voltage setting and shutdown
- Error and Status Messages
- **Multi-Drop**
- Allows IEEE Master to control up to 31 slaves over RS-485 daisy-chain
- Only the Master needs be equipped with IEEE Interface
- Program Current
- Measure Current
- Current Foldback shutdown

**Isolated Analog Programming**

Four Channels to Program and Monitor Voltage and Current.

Isolation allows operation with floating references in harsh electrical environments.

Choose between programming with Voltage or Current.

Connection via removable terminal block: Phoenix MC1,5/8-ST-3.81.





- Voltage Programming, user-selectable 0-5V or 0-10V signal. P/N: IS510  
 Power Supply Voltage and Current Programming Accuracy  $\pm 1\%$   
 Power Supply Voltage and Current Monitoring Accuracy  $\pm 1.5\%$
- Current Programming with 4-20mA signal. P/N: IS420  
 Power Supply Voltage and Current Programming Accuracy  $\pm 1\%$   
 Power Supply Voltage and Current Monitoring Accuracy  $\pm 1.5\%$

**LAN Interface**

P/N: LAN

- VISA & SCPI Compatible
- Address Viewable on Front Panel
- Fixed and Dynamic Addressing
- Compatible with most standard Networks
- TCP / UDP Socket Programming
- LAN Fault Indicators
- Auto-detects LAN Cross-over Cable
- Fast Startup

**AC Cord**

Region	Europe	Japan	North America	Israel
Output Power	850W	850W	850W	850W
AC Cords	10A/250Vac L=2m	15A/125Vac L=2m	13A/125Vac L=2m	10A/250Vac L=2m
Wall Plug	INT'L 7/VII	JIS C8303	NEMA 5-15P	SI-32
Power Supply Connector	IEC320-C15	IEC320-C15	IEC320-C15	IEC320-C15
				
Part Number	P/N: Z-E	P/N: Z-J	P/N : Z-U	P/N: Z-I

**Communication Cable**

RS-232/RS-485 Cable is used to connect the power supply to the PC Controller

Mode	RS-485	RS-232
PC Connector	DB-9F	DB-9F
Communication Cable	Shield Ground L=2m	Shield Ground L=2m
Power Supply Connector	EIA/TIA-568A (RJ-45)	EIA/TIA-568A (RJ-45)
P/N	Z/485-9	Z/232-9

**Serial Link Cable\***

Daisy-chain up to 31 Z<sup>+</sup> Series power supplies.

Mode	Power Supply Connector	Communication Cable	P/N
RS-485	EIA/TIA-568A (RJ-45)	Shield Ground	Z/RJ45

\* Included with power supply



**Power Supply Identification / Accessories**  
**How to order**

Z	650 -	1.25-	-	-	
Series Name	Output Voltage (0~650V)	Output Current (0~1.25A)	Factory Options:	Output Jack	AC cord Options: Region :
			IEEE		E - Europe
			LAN		J - Japan
			IS510	L2	U - North America
			IS420		I - Middle East
					C - China

**Factory option**

	P/N
USB Interface built-in Standard	-
RS-232/RS-485 Interface built-in Standard	-
GPIB Interface	IEEE
Voltage Programming Isolated Analog Interface	IS510
Current Programming Isolated Analog Interface	IS420
LAN Interface	LAN
Front panel insulated output sockets (Ø 4mm) for modules up to 650V or 5A Max	L2

Model	Output Voltage (VDC)	Output Current (A)	Output Power (W)
Z160-1.3	0~160 VDC	0~1.3	208
Z160-2.6		0~2.6	416
Z160-4		0~4	640
Z160-5		0~5	800
Z320-0.65	0~320 VDC	0~0.65	208
Z320-1.3		0~1.3	416
Z320-2		0~2	640
Z320-2.5		0~2.5	800
Z375-2.2	0~375VDC	0~2.2	825
Z650-0.32	0~650 VDC	0~0.32	208
Z650-0.64		0~0.64	416
Z650-1		0~1	650
Z650-1.25		0~1.25	812

## Z<sup>+</sup> 200 Series Specifications

MODEL	Z	160-1.3	320-0.65	650-0.32
1. Rated output voltage(*1)	V	160	320	650
2. Rated output current (*2)	A	1.3	0.65	0.32
3. Rated output power	W	208	208	208

CONSTANT VOLTAGE MODE		Z	160-13	320-0.65	650-0.32
1. Max. Line regulation (*6)		---	0.01% of rated output voltage		
2. Max. Load regulation (*7)		---	0.01% of rated output voltage		
3. Ripple and noise (p-p, 20MHz) (*14)		mV	100	150	250
4. Ripple r.m.s. 5Hz~1MHz (*14)		mV	10	25	60
5. Temperature coefficient		PPM/°C	30PPM/°C from rated output voltage, following 30 minutes warm-up.		
6. Temperature stability		---	0.02% of rated Vout over 8hrs. interval following 30 minutes warm-up. Constant line, load & temp.		
7. Warm-up drift		---	Less than 0.05% of rated output voltage over 30 minutes following power on.		
8. Remote sense compensation/wire		V	5	5	5
9. Up-prog. Response time, 0~Vomax.(*9)		mS	110	170	170
10. Down-prog. response time:		Full load (*9)	mS	180	270
		No load (*10)	S	2	2.5
11. Transient response time		mS	Time for output voltage to recover within 0.5% of its rated output for a load change 10~90% of rated output current. Output set-point: 10~100%, Local sense Less than 2mS.		
12. Hold-up time (*19)		---	16mSec Typical.		15mSec Typical.

CONSTANT CURRENT MODE		Z	160-1.3	320-0.65	650-0.32
1. Max. Line regulation (*6)		---	0.02% of rated output current		
2. Max. Load regulation (*11)		---	0.09% of rated output current		0.15% of rated output current
3. Load regulation thermal drift		---	Less than 0.05% of rated output current over 30 minutes following load change.		
4. Ripple r.m.s. 5Hz~1MHz (*12) (*14)		mA	1.2	0.8	0.5
5. Temperature coefficient		PPM/°C	100PPM/°C from rated output current, following 30 minutes warm-up.		
6. Temperature stability		---	0.05% of rated Iout over 8hrs. interval following 30 minutes warm-up. Constant line, load & temperature.		
7. Warm-up drift		---	Less than +/-0.1% of rated output current over 30 minutes following power on.		

PROTECTIVE FUNCTIONS		Z	160-1.3	320-0.65	650-0.32
1. Foldback protection		---	Output shut-down when power supply change mode from CV to CC or CC to CV. User presetable. Reset by AC input recycle in autostart mode or by OUTPUT button or by rear panel ENABLE, or by communication port.		
2. Over-voltage protection (OVP)		---	Inverter Shut down method. Reset by AC input recycle in autostart mode or by OUTPUT button or by rear panel ENABLE, or by communication port.		
3. Over -voltage trip point		V	5~176	5~353	5~717
4. Output under voltage limit (UVL)		---	Preset by front panel or communication port. Prevents from adjusting Vout below limit. Does not affect in analog programming.		
5. Output under voltage protection (UVP)		---	Output shut-down when power supply output voltage goes below UVP programming. User presetable. Reset by AC input recycle in autostart mode or by OUTPUT button or by rear panel ENABLE, or by communication port.		
6. Over temperature protection		---	User selectable, latched or non latched.		

ANALOG PROGRAMMING AND MONITORING		Z	160-1.3	320-0.65	650-0.32
1. Vout voltage programming		---	0~100%, 0~5V or 0~10V, user selectable. Accuracy and linearity: +/-0.5% of rated Vout.		
2. Iout voltage programming (*13)		---	0~100%, 0~5V or 0~10V, user selectable. Accuracy and linearity: +/-1% of rated Iout.		
3. Vout resistor programming		---	0~100%, 0~5/10Kohm full scale, user selectable. Accuracy and linearity: +/-1% of rated Vout.		
4. Iout resistor programming (*13)		---	0~100%, 0~5/10Kohm full scale, user selectable. Accuracy and linearity: +/-1.5% of rated Iout.		
5. Shut Off (SO) control		---	By electrical Voltage: 0~0.6V/4~15V or dry contact, user selectable logic.		
6. Output current monitor (*13)		---	0~5V or 0~10V, user selectable. Accuracy: +/-1%.		
7. Output voltage monitor		---	0~5V or 0~10V, user selectable. Accuracy: +/-1%.		
8. Power supply OK signal		---	4~5V-OK, 0V-Fail. 500ohm series resistance.		
9. Parallel operation (*8)		---	Possible, up to 6 units in master/slave mode with single wire current balance connection.		
10. Series operation		---	2 identical units (with external diodes).		
11. CV/CC indicator		---	Open collector. CC mode: On, CV mode: Off. Maximum voltage: 30V, maximum sink current: 10mA		
12. Interlock (ILC) control		---	Enables/Disables the PS output by dry contact (Short: On, Open: Off, Source current: less than 0.5mA). Ena/Dis is activated by front panel.		
13. Local/Remote mode Control		---	By electrical signal or Open/Short: 0~0.6V or short: Remote, 2~15V or open: Local		
14. Local/Remote mode Indicator		---	Open collector (shunted by 36V zener). On (0~0.6V, 10mA sink current max.)-Remote. Off-Local (30V max.).		
15. Trigger out		---	Maximum low level output =0.8V, Minimum high level output =3.8V, Maximum high level output =5V, Maximum source current =16mA, pulse =20µs Typical.		
16. Trigger in		---	Maximum low level input =1.2V, Minimum high level input =3.5V, Maximum high level input =5V, Maximum sink current =16mA, positive edge, trigger: tw =10µs minimum, Tr/Tf =1µs maximum.		
17. Programmed signal 1		---	Open collector, maximum voltage 25V, maximum sink current 100mA. (Shunted by 27V zener)		
18. Programmed signal 2		---	Open collector, maximum voltage 25V, maximum sink current 100mA. (Shunted by 27V zener)		

FRONT PANEL		Z	160-1.3	320-0.65	650-0.32
1. Control functions		---	Multiple options with 2 Encoders		
		---	Vout/Iout manual adjust		
		---	OVP/UVL/UVP manual adjust		
		---	Protection Functions - OVP, UVL, UVP, Foldback, OCP, INT, SO		
		---	Communication Functions - Selection of LAN, IEEE (*17), RS232, RS485, USB		
		---	Communication Functions - Selection of Baud Rate, Address		
		---	Analog Control Functions - Selection Voltage/resistive programming, 5V/10V, 5K/10K programming		
		---	Analog Control Functions - Selection of Voltage/Current Monitoring 5V/10V, Output ON/OFF, Front Panel Lock.		

FRONT PANEL		
2. Display	---	Vout: 4 digits, accuracy: 0.5% of rated output voltage+/-1 count. Iout: 4 digits, accuracy: 0.5% of rated output current+/-1 count.
3. Indications	---	GREEN LEDs: FINE, MENU, PREV, PROT, REM, OUTPUT, CV, CC RED LED: PROT (OVP, UVP, OTP, FOLD, AC FAIL).
4. Function buttons	---	FINE, MENU, PREV, PROT, REM, OUTPUT

PROGRAMMING AND READBACK (RS232/485,USB, Optional: IEEE(*17), LAN)		
1. Vout programming accuracy	---	0.05% of actual + 0.05% of rated output voltage
2. Iout programming accuracy (*13)	---	0.2% of rated output current
3. Vout programming resolution	---	0.012% of full scale
4. Iout programming resolution	---	0.012% of full scale
5. Vout readback accuracy	---	0.05% of actual + 0.05% of rated output voltage
6. Iout readback accuracy (*13)	---	0.1% of actual +0.3% of rated output current
7. Vout readback resolution	---	0.012% of full scale
8. Iout readback resolution	---	0.012% of full scale

INPUT CHARACTERISTICS		
1. Input voltage/freq. (*3)	Z	160-1.3 320-0.65 650-0.32
2. Maximum Input current 100/200VAC (*4) (*15)	---	85~265Vac continuous, 47~63Hz, single phase
3. Power Factor (Typ)	---	2.64/1.30 2.64/1.30 2.64/1.30
4. Efficiency (Typ) 100/200VAC (*4) (*15)	---	>0.99 at 100Vac, >0.98 at 200Vac, 100% load
5. Inrush current 100/200VAC (*5)	---	79/81 79/81 79/81 Less than 25A

ENVIRONMENTAL CONDITIONS		
1. Operating temperature	---	0~50°C, 100% load.
2. Storage temperature	---	-20~85°C
3. Operating humidity	%	20~90% RH (no condensation).
4. Storage humidity	%	10~95% RH (no condensation).
5. Altitude	---	Maximum 3000m. Derate ambient temp above 2000m. Operating: Maximum ambient temperature, From 2000m up to 3000m Ambient temperature 40°C.

SAFETY/EMC		
1. Applicable standards:	Safety	---
	EMC	---
2. Interface classification		UL61010-1, EN61010-1, IEC61010-1. Built to meet UL60950-1, EN60950-1 160V≤Vout≤650V: Output, J1, J2 are Hazardous. J3, J4, USB, IEEE/ISOLATED Analog, LAN are Non Hazardous IEC/EN61326-1 (Built to meet EN55022/EN55024)
		Output floating: Output, J1, J2 are Hazardous; J3, J4, USB, LAN, IEEE/ISOLATED ANALOG are Non Hazardous Vout≤400V, +Output grounded: Output, J1, J2 are Hazardous; J3, J4, USB, LAN, IEEE/ISOLATED ANALOG are Non Hazardous Vout>400V, +Output grounded: Output, J1, J2, J3, J4, USB, LAN, IEEE/ISOLATED ANALOG are Hazardous
3. Withstand voltage	---	160≤Vout≤320V models: Input-Output&J1, J2: 2970VDC/1min; Input-Ground: 2828VDC/1min. Output&J1, J2, -Ground: 2000VDC/1min; Output&J1, J2- J3, J4, USB, LAN/IEEE/ISOLATED ANALOG :3200VDC/1min; Input-J3, J4, USB, LAN/IEEE/ISOLATED ANALOG: 4242VDC/1min; J3, J4, USB, LAN/IEEE/ISOLATED ANALOG Input-Ground: 707VDC/1min. 650V model: Input-Output&J1, J2: 3704VDC/1min; Input-Ground: 2828VDC/1min. Output&J1, J2, -Ground: 2780VDC/1min; Output&J1, J2- J3, J4, USB, LAN/IEEE/ISOLATED ANALOG :4244VDC/1min; Input-J3, J4, USB, LAN/IEEE/ISOLATED ANALOG: 4242VDC/1min; J3, J4, USB, LAN/IEEE/ISOLATED ANALOG Input-Ground: 707VDC/1min.
4. Insulation resistance	---	More than 100Mohm at 25°C, 70%RH.
5. Conducted emission	---	IEC/EN61326-1 Industrial Location - B, FCC part 15-B, VCCI-B
6. Radiated emission	---	IEC/EN61326-1 Industrial Location - A, FCC part 15-A, VCCI-A

MECHANICAL		
1. Cooling	---	Forced air cooling by internal fan.
2. Weight	STANDARD	Kg
	WIDE BODY	Kg
3. Dimensions (WxHxD)	STANDARD	mm
	WIDE BODY	mm
4. Vibration	---	According to: IEC60068-2-64
5. Shock	---	Less than 20G, half sine, 11mS. Unit is unpacked. According to: IEC60068-2-27

**NOTES:**

- \*1: Minimum voltage is guaranteed to maximum 0.1% of rated output voltage.
- \*2: Minimum current is guaranteed to maximum 0.2% of rated output current.
- \*3: For cases where conformance to various safety standards (UL, IEC, etc...) is required, to be described as 100-240Vac (50/60Hz).
- \*4: Ta=25°C with rated output power.
- \*5: Not including EMI filter inrush current, less than 0.2mSec at cold start Ta=25°C
- \*6: At 85~132Vac or 170~265VAC, constant load.
- \*7: From No-Load to Full-Load, constant input voltage. Measured at the sensing point in Remote Sense.
- \*8: For parallel operation up to 4 units, 5% of total output current is required.  
For parallel operation more than 4 units, 20% of total output current is required.
- \*9: From 10% to 90% or 90% to 10% of Rated Output Voltage, with rated resistive load.
- \*10: From 90% to 10% of Rated Output Voltage.
- \*11: For load voltage change, equal to the unit voltage rating, constant input voltage.
- \*12: Ripple is measured at 10~100% of rated output voltage and rated output current.
- \*13: The Constant Current programming, readback and monitoring accuracy do not include the warm-up and Load regulation thermal drift.
- \*14: Measured with 10:1 probe.
- \*15: P.S with Lan, IEEE, models decrease efficiency by 0.5% and increase input current by 0.5%.  
P.S with Isolated analog option decreases efficiency by 1.5% and increases input current by 1.5%.
- \*16: At rated output power.
- \*17: Max. ambient temperature for using IEEE is 45°C.

# Z<sup>+</sup> 400 Series Specifications

MODEL	Z	160-2.6	320-1.3	650-0.64
1. Rated output voltage(*1)	V	160	320	650
2. Rated output current (*2)	A	2.6	1.3	0.64
3. Rated output power	W	416	416	416

CONSTANT VOLTAGE MODE		Z	160-2.6	320-1.3	650-0.64
1. Max. Line regulation (*6)		---	0.01% of rated output voltage		
2. Max. Load regulation (*7)		---	0.01% of rated output voltage		
3. Ripple and noise (p-p, 20MHz) (*14)	mV		100	150	250
4. Ripple r.m.s. 5Hz~1MHz (*14)	mV		10	25	60
5. Temperature coefficient	PPM/°C		30PPM/°C from rated output voltage, following 30 minutes warm-up.		
6. Temperature stability		---	0.02% of rated Vout over 8hrs. interval following 30 minutes warm-up. Constant line, load & temp.		
7. Warm-up drift		---	Less than 0.05% of rated output voltage over 30 minutes following power on.		
8. Remote sense compensation/wire	V		5	5	5
9. Up-prog. Response time, 0~Vomax.(*9)	mS		80	150	150
10. Down-prog. response time:	Full load (*9)		100	150	150
	No load (*10)	S	2	2.5	3
11. Transient response time	mS		Time for output voltage to recover within 0.5% of its rated output for a load change 10~90% of rated output current. Output set-point: 10~100%, Local sense. Less than 2mS.		
12. Hold-up time (*19)		---	16mSec Typical.		15mSec Typical.

CONSTANT CURRENT MODE		Z	160-2.6	320-1.3	650-0.64
1. Max. Line regulation (*6)		---	0.02% of rated output current		
2. Max. Load regulation (*11)		---	0.09% of rated output current		
3. Load regulation thermal drift		---	Less than 0.05% of rated output current over 30 minutes following load change.		
4. Ripple r.m.s. 5Hz~1MHz (*12) (*14)	mA		1.5	1	0.6
5. Temperature coefficient	PPM/°C		100PPM/°C from rated output current, following 30 minutes warm-up.		
6. Temperature stability		---	0.05% of rated Iout over 8hrs. interval following 30 minutes warm-up. Constant line, load & temperature.		
7. Warm-up drift		---	Less than +/-0.1% of rated output current over 30 minutes following power on.		

PROTECTIVE FUNCTIONS		Z	160-2.6	320-1.3	650-0.64
1. Foldback protection		---	Output shut-down when power supply change mode from CV to CC or CC to CV. User presetable. Reset by AC input recycle in autostart mode or by OUTPUT button or by rear panel ENABLE, or by communication port.		
2. Over-voltage protection (OVP)		---	Inverter Shut down method. Reset by AC input recycle in autostart mode or by OUTPUT button or by rear panel ENABLE, or by communication port.		
3. Over -voltage trip point	V		5~176	5~353	5~717
4. Output under voltage limit (UVL)		---	Preset by front panel or communication port. Prevents from adjusting Vout below limit. Does not affect in analog programming.		
5. Output under voltage protection (UVP)		---	Output shut-down when power supply output voltage goes below UVP programming. User presetable. Reset by AC input recycle in autostart mode or by OUTPUT button or by rear panel ENABLE, or by communication port.		
6. Over temperature protection		---	User selectable, latched or non latched.		
5. Output under voltage protection (UVP)		---	Output shut-down when power supply output voltage goes below UVP programming. User presetable. Reset by AC input recycle in autostart mode or by OUTPUT button or by rear panel ENABLE, or by communication port.		
6. Over temperature protection		---	User Selectable. Latched or non latched		

ANALOG PROGRAMMING AND MONITORING					
1. Vout voltage programming		---	0~100%, 0~5V or 0~10V, user selectable. Accuracy and linearity: +/-0.5% of rated Vout.		
2. Iout voltage programming (*13)		---	0~100%, 0~5V or 0~10V, user selectable. Accuracy and linearity: +/-1% of rated Iout.		
3. Vout resistor programming		---	0~100%, 0~5/10Kohm full scale, user selectable. Accuracy and linearity: +/-1% of rated Vout.		
4. Iout resistor programming (*13)		---	0~100%, 0~5/10Kohm full scale, user selectable. Accuracy and linearity: +/-1.5% of rated Iout.		
5. Shut Off (SO) control		---	By electrical Voltage: 0~0.6V/4~15V or dry contact, user selectable logic.		
6. Output current monitor (*13)		---	0~5V or 0~10V, user selectable. Accuracy: +/-1%.		
7. Output voltage monitor		---	0~5V or 0~10V, user selectable. Accuracy: +/-1%.		
8. Power supply OK signal		---	4~5V-OK, 0V-Fail. 500ohm series resistance.		
9. Parallel operation (*8)		---	Possible, up to 6 units in master/slave mode with single wire current balance connection.		
10. Series operation		---	2 identical units (with external diodes).		
11. CV/CC indicator		---	Open collector. CC mode: On, CV mode: Off. Maximum voltage: 30V, maximum sink current: 10mA		
12. Interlock (ILC) control		---	Enables/Disables the PS output by dry contact (Short: On, Open: Off, Source current: less than 0.5mA). Ena/Dis is activated by front panel.		
13. Local/Remote mode Control		---	By electrical signal or Open/Short: 0~0.6V or short: Remote, 2~15V or open: Local		
14. Local/Remote mode Indicator		---	Open collector (shunted by 36V zener). On (0~0.6V, 10mA sink current max.)-Remote. Off-Local (30V max.).		
15. Trigger out		---	Maximum low level output =0.8V, Minimum high level output =3.8V, Maximum high level output =5V, Maximum source current =16mA, pulse =20µs Typical.		
16. Trigger in		---	Maximum low level input =1.2V, Minimum high level input =3.5V, Maximum high level input =5V, Maximum sink current =16mA, positive edge, trigger: tw =10µs minimum, Tr/Tf =1µs maximum.		
17. Programmed signal 1		---	Open collector, maximum voltage 25V, maximum sink current 100mA. (Shunted by 27V zener)		
18. Programmed signal 2		---	Open collector, maximum voltage 25V, maximum sink current 100mA. (Shunted by 27V zener)		

FRONT PANEL					
1. Control functions		---	Multiple options with 2 Encoders		
		---	Vout/Iout manual adjust		
		---	OVP/UVL/UVP manual adjust		
		---	Protection Functions - OVP, UVL, UVP, Foldback, OCP, INT, SO		
		---	Communication Functions - Selection of LAN,IEEE (*20), RS232,RS485,USB		
		---	Communication Functions - Selection of Baud Rate, Address		
		---	Analog Control Functions - Selection Voltage/resistive programming, 5V/10V, 5K/10K programming		
	---	---	Analog Control Functions - Selection of Voltage/Current Monitoring 5V/10V, Output ON/OFF, Front Panel Lock.		

FRONT PANEL		
2. Display	---	Vout: 4 digits, accuracy: 0.5% of rated output voltage+/-1 count. Iout: 4 digits, accuracy: 0.5% of rated output current+/-1 count.
3. Indications	---	GREEN LEDs: FINE, MENU, PREV, PROT, REM, OUTPUT, CV, CC RED LED: PROT (OVP, UVP, OTP, FOLD, AC FAIL).
4. Function buttons	---	FINE, MENU, PREV, PROT, REM, OUTPUT

PROGRAMMING AND READBACK (RS232/485,USB, Optional: IEEE(*17), LAN)		
1. Vout programming accuracy	---	0.05% of actual + 0.05% of rated output voltage
2. Iout programming accuracy (*13)	---	0.2% of rated output current
3. Vout programming resolution	---	0.012% of full scale
4. Iout programming resolution	---	0.012% of full scale
5. Vout readback accuracy	---	0.05% of actual + 0.05% of rated output voltage
6. Iout readback accuracy (*13)	---	0.1% of actual +0.3% of rated output current
7. Vout readback resolution	---	0.012% of full scale
8. Iout readback resolution	---	0.012% of full scale

INPUT CHARACTERISTICS		
1. Input voltage/freq. (*3)	Z	160-2.6 320-1.3 650-0.64
2. Maximum Input current 100/200VAC (*4) (*15)	---	85~265Vac continuous, 47~63Hz, single phase
3. Power Factor (Typ)	---	5/2.44 5/2.44 5/2.44
4. Efficiency (Typ) 100/200VAC (*4) (*15)	%	0.99 at 100/200Vac,100% load
5. Inrush current 100/200VAC (*5)	---	84/86 84/86 84/86
		Less than 25A

ENVIRONMENTAL CONDITIONS		
1. Operating temperature	---	0~50°C, 100% load.
2. Storage temperature	---	-20~85°C
3. Operating humidity	%	20~90% RH (no condensation).
4. Storage humidity	%	10~95% RH (no condensation).
5. Altitude	---	Maximum 3000m. Derate ambient temp above 2000m. Operating: Maximum ambient temperature, From 2000m up to 3000m Ambient temperature 40°C.

SAFETY/EMC		
1. Applicable standards:	Safety	UL61010-1, EN61010-1, IEC61010-1. Built to meet UL60950-1, EN60950-1 160V≤Vout≤650V: Output,J1,J2 are Hazardous. J3,J4,USB, IEEE/ISOLATED Analog ,LAN are Non Hazardous
	EMC	IEC/EN61326-1 (Built to meet EN55022/EN55024)
2. Interface classification		Output floating: Output, J1, J2 are Hazardous; J3, J4, USB, LAN, IEEE/ISOLATED ANALOG are Non Hazardous Vout≤400V, +Output grounded: Output, J1, J2 are Hazardous; J3, J4, USB, LAN, IEEE/ISOLATED ANALOG are Non Hazardous Vout>400V, +Output grounded: Output, J1, J2, J3, J4, USB, LAN, IEEE/ISOLATED ANALOG are Hazardous
3. Withstand voltage	---	160≤Vout≤320V models: Input-Output&J1,J2: 2970VDC/1min; Input-Ground: 2828VDC/1min. Output&J1,J2,-Ground: 2000VDC/1min; Output&J1,J2- J3,J4,USB,LAN/IEEE/ISOLATED ANALOG :3200VDC/1min; Input-J3,J4,USB,LAN/IEEE/ISOLATED ANALOG: 4242VDC/1min; J3,J4,USB,LAN/IEEE/ISOLATED ANALOG Input-Ground: 707VDC/1min. 650V model: Input-Output&J1,J2: 3704VDC/1min; Input-Ground: 2828VDC/1min. Output&J1,J2,-Ground: 2780VDC/1min; Output&J1,J2- J3,J4,USB,LAN/IEEE/ISOLATED ANALOG :4244VDC/1min; Input-J3,J4,USB,LAN/IEEE/ISOLATED ANALOG: 4242VDC/1min; J3,J4,USB,LAN/IEEE/ISOLATED ANALOG Input-Ground: 707VDC/1min.
4. Insulation resistance	---	More than 100Mohm at 25°C, 70%RH.
5. Conducted emission	---	IEC/EN61326-1 Industrial Location - B, FCC part 15-B, VCCI-B
6. Radiated emission	---	IEC/EN61326-1 Industrial Location - A, FCC part 15-A, VCCI-A

MECHANICAL			
1. Cooling	---	Forced air cooling by internal fan.	
2. Weight	STANDARD	Kg	
	WIDE BODY	Kg	
			Less than 1.9Kg. Less than 2.4Kg. Wide body with Isolated analog or IEEE.
3. Dimensions (WxHxD)	STANDARD	mm	H: 83, W: 70, D: 350 (excluding bus bars, handles...). (Refer to Outline drawing).
	WIDE BODY	mm	H: 83, W: 105, D: 350 (excluding bus bars, handles...). (Refer to Outline drawing).
4. Vibration	---		According to: IEC60068-2-64
5. Shock	---		Less than 20G, half sine, 11mS. Unit is unpacked. According to: IEC60068-2-27

**NOTES:**

- \*1: Minimum voltage is guaranteed to maximum 0.1% of rated output voltage.
- \*2: Minimum current is guaranteed to maximum 0.2% of rated output current.
- \*3: For cases where conformance to various safety standards (UL, IEC, etc...) is required, to be described as 100-240Vac (50/60Hz).
- \*4: Ta=25°C with rated output power.
- \*5: Not including EMI filter inrush current, less than 0.2mSec at cold start Ta=25°C
- \*6: At 85~132Vac or 170~265VAC, constant load.
- \*7: From No-Load to Full-Load, constant input voltage. Measured at the sensing point in Remote Sense.
- \*8: For parallel operation up to 4 units, 5% of total output current is required.  
For parallel operation more than 4 units, 20% of total output current is required.
- \*9: From 10% to 90% or 90% to 10% of Rated Output Voltage, with rated resistive load.
- \*10: From 90% to 10% of Rated Output Voltage.
- \*11: For load voltage change, equal to the unit voltage rating, constant input voltage.
- \*12: Ripple is measured at 10~100% of rated output voltage and rated output current.
- \*13: The Constant Current programming, readback and monitoring accuracy do not include the warm-up and Load regulation thermal drift.
- \*14: Measured with 10:1 probe.
- \*15: P.S with Lan, IEEE, models decrease efficiency by 0.25% and increase input current by 0.25%.  
P.S with Isolated analog option decreases efficiency by 0.75% and increases input current by 0.75%.
- \*16: At rated output power.
- \*17: Max. ambient temperature for using IEEE is 45°C.

## Z<sup>+</sup> 600 Series Specifications

OUTPUT RATING	Z	160-4	320-2	650-1
1. Rated output voltage (*1)	V	160	320	650
2. Rated output current (*2)	A	4.0	2.0	1.00
3. Rated output power at 100≤Vin≤265Vac, Ta ≤ 50°C	W	640	640	650

CONSTANT VOLTAGE MODE	Z	160-4	320-2	650-1
1. Max. Line regulation (*6)	---	0.01% of rated output voltage		
2. Max. Load regulation (*7)	---	0.01% of rated output voltage		
3. Ripple and noise (p-p, 20MHz) (*14) (*17)	mV	100	150	250
4. Ripple r.m.s. 5Hz~1MHz (*14) (*17)	mV	10	30	60
5. Temperature coefficient	PPM/°C	30PPM/°C from rated output voltage, following 30 minutes warm-up.		
6. Temperature stability	---	0.02% of rated Vout over 8hrs. interval following 30 minutes warm-up. Constant line, load & temp.		
7. Warm-up drift	---	Less than 0.05% of rated output voltage over 30 minutes following power on.		
8. Remote sense compensation/wire	V	5	5	5
9. Up-prog. Response time, 0~Vomax.(*9)	mS	55	75	75
10. Down-prog. response time:	Full load (*9)	65	85	85
	No load (*10)	2	2.5	3
11. Transient response time	mS	Time for output voltage to recover within 0.5% of its rated output for a load change 10~90% of rated output current. Output set-point: 10~100%, Local sense Less than 2mS.		
12. Hold-up time (*15)	---	16mSec Typical.		14mSec Typical.

CONSTANT CURRENT MODE	Z	160-4	320-2	650-1
1. Max. Line regulation (*6)	---	0.02% of rated output current		
2. Max. Load regulation (*11)	---	0.09% of rated output current		
3. Load regulation thermal drift	---	Less than 0.05% of rated output current over 30 minutes following load change.		
4. Ripple r.m.s. 5Hz~1MHz (*12) (*14)	mA	2	1.5	1
5. Temperature coefficient	PPM/°C	100PPM/°C from rated output current, following 30 minutes warm-up.		
6. Temperature stability	---	0.05% of rated Iout over 8hrs. interval following 30 minutes warm-up. Constant line, load & temperature.		
7. Warm-up drift	---	Less than +/-0.1% of rated output current over 30 minutes following power on.		

PROTECTIVE FUNCTIONS	Z	160-4	320-2	650-1
1. Foldback protection	---	Output shut-down when power supply change mode from CV to CC or CC to CV. User presetable. Reset by AC input recycle in autostart mode or by OUTPUT button or by rear panel ENABLE, or by communication port.		
2. Over-voltage protection (OVP)	---	Inverter Shut down method. Reset by AC input recycle in autostart mode or by OUTPUT button or by rear panel ENABLE, or by communication port.		
3. Over -voltage trip point	V	5~176	5~353	5~717
4. Output under voltage limit (UVL)	---	Preset by front panel or communication port. Prevents from adjusting Vout below limit. Does not affect in analog programming.		
5. Output under voltage protection (UVP)	---	Output shut-down when power supply output voltage goes below UVP programming. User presetable. Reset by AC input recycle in autostart mode or by OUTPUT button or by rear panel ENABLE, or by communication port.		
6. Over temperature protection	---	User selectable, latched or non latched.		

ANALOG PROGRAMMING AND MONITORING				
1. Vout voltage programming	---	0~100%, 0~5V or 0~10V, user selectable. Accuracy and linearity: +/-0.5% of rated Vout.		
2. Iout voltage programming (*13)	---	0~100%, 0~5V or 0~10V, user selectable. Accuracy and linearity: +/-1% of rated Iout.		
3. Vout resistor programming	---	0~100%, 0~5/10Kohm full scale, user selectable. Accuracy and linearity: +/-1% of rated Vout.		
4. Iout resistor programming (*13)	---	0~100%, 0~5/10Kohm full scale, user selectable. Accuracy and linearity: +/-1.5% of rated Iout.		
5. Shut Off (SO) control	---	By electrical Voltage: 0~0.6V/4~15V or dry contact, user selectable logic.		
6. Output current monitor (*13)	---	0~5V or 0~10V, user selectable. Accuracy: +/-1%.		
7. Output voltage monitor	---	0~5V or 0~10V, user selectable. Accuracy: +/-1%.		
8. Power supply OK signal	---	4~5V-OK, 0V-Fail. 500ohm series resistance.		
9. Parallel operation (*8)	---	Possible, up to 6 units in master/slave mode with single wire current balance connection.		
10. Series operation	---	2 identical units (with external diodes).		
11. CV/CC indicator	---	Open collector. CC mode: On, CV mode: Off. Maximum voltage: 30V, maximum sink current: 10mA		
12. Interlock (ILC) control	---	Enables/Disables the PS output by dry contact (Short: On, Open: Off, Source current: less than 0.5mA). Ena/Dis is activated by front panel.		
13. Local/Remote mode Control	---	By electrical signal or Open/Short: 0~0.6V or short: Remote, 2~15V or open: Local		
14. Local/Remote mode Indicator	---	Open collector (shunted by 36V zener). On (0~0.6V, 10mA sink current max.)-Remote. Off-Local (30V max.).		
15. Trigger out	---	Maximum low level output =0.8V, Minimum high level output =3.8V, Maximum high level output =5V, Maximum source current =16mA, pulse =20μs Typical.		
16. Trigger in	---	Maximum low level input =1.2V, Minimum high level input =3.5V, Maximum high level input =5V, Maximum sink current =16mA, positive edge, trigger: tw =10μs minimum, Tr/Tf =1μs maximum.		
17. Programmed signal 1	---	Open collector, maximum voltage 25V, maximum sink current 100mA. (Shunted by 27V zener)		
18. Programmed signal 2	---	Open collector, maximum voltage 25V, maximum sink current 100mA. (Shunted by 27V zener)		

FRONT PANEL				
1. Control functions	---	Multiple options with 2 Encoders		
	---	Vout/Iout manual adjust		
	---	OVP/UVL/UVP manual adjust		
	---	Protection Functions - OVP, UVL, UVP, Foldback, OCP, INT, SO		
	---	Communication Functions - Selection of LAN, IEEE (*17), RS232, RS485, USB		
	---	Communication Functions - Selection of Baud Rate, Address		
	---	Analog Control Functions - Selection Voltage/resistive programming, 5V/10V, 5K/10K programming		
---	Analog Control Functions - Selection of Voltage/Current Monitoring 5V/10V, Output ON/OFF, Front Panel Lock.			

FRONT PANEL		
2. Display	---	Vout: 4 digits, accuracy: 0.5% of rated output voltage+/-1 count. Iout: 4 digits, accuracy: 0.5% of rated output current+/-1 count.
3. Indications	---	GREEN LEDs: FINE, MENU, PREV, PROT, REM, OUTPUT, CV, CC RED LED: PROT (OVP, UVP, OTP, FOLD, AC FAIL).
4. Function buttons	---	FINE, MENU, PREV, PROT, REM, OUTPUT

PROGRAMMING AND READBACK (RS232/485,USB, Optional: IEEE (*16), LAN)		
1. Vout programming accuracy	---	0.05% of actual + 0.05% of rated output voltage
2. Iout programming accuracy (*13)	---	0.2% of rated output current
3. Vout programming resolution	---	0.012% of full scale
4. Iout programming resolution	---	0.012% of full scale
5. Vout readback accuracy	---	0.05% of actual + 0.05% of rated output voltage
6. Iout readback accuracy (*13)	---	0.1% of actual +0.3% of rated output current
7. Vout readback resolution	---	0.012% of full scale
8. Iout readback resolution	---	0.012% of full scale

INPUT CHARACTERISTICS	Z	160-4	320-2	650-1
1. Input voltage/freq. (*3)	---	85~265Vac continuous, 47~63Hz, single phase		
2. Maximum Input current 100/200VAC (*4)	---	7.5/3.7	7.5/3.7	7.6/3.75
3. Power Factor (Typ)	---	>0.99 at 100Vac, >0.98 at 200Vac, 100% load		
4. Efficiency (Typ) 100/200VAC (*4)	%	86.5/88.5	87/88.5	86.5/88.5
5. Inrush current 100/200VAC (*5)	---	Less than 30A		

ENVIRONMENTAL CONDITIONS		
1. Operating temperature	---	0~50°C, 100% load.
2. Storage temperature	---	-20~85°C
3. Operating humidity	%	20~90% RH (no condensation).
4. Storage humidity	%	10~95% RH (no condensation).
5. Altitude	---	Maximum 3000m. Derate ambient temp above 2000m. Operating: Maximum ambient temperature, From 2000m up to 3000m Ambient temperature 40°C.

SAFETY/EMC		
1. Applicable standards:	Safety	---
	EMC	---
2. Interface classification	UL61010-1, EN61010-1, IEC61010-1. Built to meet UL60950-1, EN60950-1 160V≤Vout≤650V: Output, J1, J2 are Hazardous. J3, J4, USB, IEEE/ISOLATED Analog, LAN are Non Hazardous IEC/EN61326-1 (Built to meet EN55022/EN55024)	
	Output floating: Output, J1, J2 are Hazardous; J3, J4, USB, LAN, IEEE/ISOLATED ANALOG are Non Hazardous	
	Vout≤400V, +Output grounded: Output, J1, J2 are Hazardous; J3, J4, USB, LAN, IEEE/ISOLATED ANALOG are Non Hazardous Vout>400V, +Output grounded: Output, J1, J2, J3, J4, USB, LAN, IEEE/ISOLATED ANALOG are Hazardous	
3. Withstand voltage	160≤Vout≤320V models: Input-Output&J1, J2: 2970VDC/1min; Input-Ground: 2828VDC/1min. Output&J1, J2, -Ground: 2000VDC/1min; Output&J1, J2- J3, J4, USB, LAN/IEEE/ISOLATED ANALOG :3200VDC/1min; Input-J3, J4, USB, LAN/IEEE/ISOLATED ANALOG: 4242VDC/1min; J3, J4, USB, LAN/IEEE/ISOLATED ANALOG Input-Ground: 707VDC/1min. 650V model: Input-Output&J1, J2: 3704VDC/1min; Input-Ground: 2828VDC/1min. Output&J1, J2, -Ground: 2780VDC/1min; Output&J1, J2- J3, J4, USB, LAN/IEEE/ISOLATED ANALOG :4244VDC/1min; Input-J3, J4, USB, LAN/IEEE/ISOLATED ANALOG: 4242VDC/1min; J3, J4, USB, LAN/IEEE/ISOLATED ANALOG Input-Ground: 707VDC/1min.	
	More than 100Mohm at 25°C, 70%RH.	
4. Insulation resistance	---	More than 100Mohm at 25°C, 70%RH.
5. Conducted emission	---	IEC/EN61326-1 Industrial Location - B, FCC part 15-B, VCCI-B
6. Radiated emission	---	IEC/EN61326-1 Industrial Location - A, FCC part 15-A, VCCI-A

MECHANICAL		
1. Cooling	---	Forced air cooling by internal fan.
2. Weight	STANDARD	Kg
	WIDE BODY	Kg
3. Dimensions (WxHxD)	STANDARD	mm
	WIDE BODY	mm
4. Vibration	---	According to: IEC60068-2-64
5. Shock	---	Less than 20G, half sine, 11mS. Unit is unpacked. According to: IEC60068-2-27

**NOTES:**

- \*1: Minimum voltage is guaranteed to maximum 0.1% of rated output voltage.
- \*2: Minimum current is guaranteed to maximum 0.2% of rated output current.
- \*3: For cases where conformance to various safety standards (UL, IEC, etc...) is required, to be described as 100-240Vac (50/60Hz).
- \*4: Ta=25°C with rated output power.
- \*5: Not including EMI filter inrush current, less than 0.2mSec.
- \*6: At 85~132Vac or 170~265VAC, constant load.
- \*7: From No-Load to Full-Load, constant input voltage. Measured at the sensing point in Remote Sense.
- \*8 For Parallel operation up to 4 units, 5% of total output current is required.  
For Parallel operation more than 4 units, 20% of total output current is required.
- \*9: From 10% to 90% or 90% to 10% of rated output voltage, with rated resistive load.
- \*10: From 90% to 10% of rated output voltage.
- \*11: For load voltage change, equal to the unit voltage rating, constant input voltage.
- \*12: Ripple is measured at 10~100% of rated output voltage and rated output current.
- \*13: The Constant Current programming, readback and monitoring accuracy do not include the warm-up and Load regulation thermal drift.
- \*14: Measured with 10:1 probe.
- \*15: At rated output power.
- \*16 Max. ambient temperature for using IEEE is 45°C.
- \*17: start in low ambient temp. (0°C), 1 min. warm up is required

## Z<sup>+</sup> 800 Series Specifications

OUTPUT RATING	Z	160-5	320-2.5	375-2.2	650-1.25
1. Rated output voltage (*1)	V	160	320	375	650
2. Rated output current (*2) at 100≤Vin≤265Vac, Ta ≤ 50°C Rated output current (*2) at 85≤Vin<100Vac, Ta ≤ 40°C Rated output current (*2) at 85≤Vin<100Vac, 40°C < Ta ≤ 50°C	A	5.0	2.5	2.2	1.25
		5.0	2.5	2.2	1.25
		4.7	2.35	2.0	1.15
3. Rated output power at 100≤Vin≤265Vac, Ta ≤ 50°C Rated output power at 85≤Vin<100Vac, Ta ≤ 40°C Rated output power at 85≤Vin<100Vac, 40°C < Ta ≤ 50°C	W	800	800	825	812.5
		800	800	825	812.5
		752	752	750	747.5

CONSTANT VOLTAGE MODE	Z	160-5	320-2.5	375-2.2	650-1.25
1. Max. Line regulation (*6)	---	0.01% of rated output voltage			
2. Max. Load regulation (*7)	---	0.01% of rated output voltage			
3. Ripple and noise (p-p, 20MHz) (*14) (*17)	mV	100	150	150	250
4. Ripple r.m.s. 5Hz~1MHz (*14) (*17)	mV	10	30	30	60
5. Temperature coefficient	PPM/°C	30PPM/°C from rated output voltage, following 30 minutes warm-up.			
6. Temperature stability	---	0.02% of rated Vout over 8hrs. interval following 30 minutes warm-up. Constant line, load & temp.			
7. Warm-up drift	---	Less than 0.05% of rated output voltage over 30 minutes following power on.			
8. Remote sense compensation/wire	V	5	5	5	5
9. Up-prog. Response time, 0~Vomax. (*9)	mS	45	55	55	55
10. Down-prog. response time:	Full load (*9)	mS	55	65	65
	No load (*10)	S	2	2.5	3
11. Transient response time	mS	Time for output voltage to recover within 0.5% of its rated output for a load change 10~90% of rated output current. Output set-point: 10~100%, Local sense Less than 2mS.			
12. Hold-up time (*15)	mS	13msec Typical.		11.5msec Typical.	

CONSTANT CURRENT MODE	Z	160-5	320-2.5	375-2.2	650-1.25
1. Max. Line regulation (*6)	---	0.02% of rated output current			
2. Max. Load regulation (*11)	---	0.09% of rated output current			
3. Load regulation thermal drift	---	Less than 0.05% of rated output current over 30 minutes following load change.			
4. Ripple r.m.s. 5Hz~1MHz (*12) (*14)	mA	2	1.5	1.5	1
5. Temperature coefficient	PPM/°C	100PPM/°C from rated output current, following 30 minutes warm-up.			
6. Temperature stability	---	0.05% of rated Iout over 8hrs. interval following 30 minutes warm-up. Constant line, load & temperature.			
7. Warm-up drift	---	Less than +/-0.1% of rated output current over 30 minutes following power on.			

PROTECTIVE FUNCTIONS	Z	160-5	320-2.5	375-2.2	650-1.25
1. Foldback protection	---	Output shut-down when power supply change mode from CV to CC or CC to CV. User presettable. Reset by AC input recycle in autostart mode or by OUTPUT button or by rear panel ENABLE, or by communication port.			
2. Over-voltage protection (OVP)	---	Inverter Shut down method. Reset by AC input recycle in autostart mode or by OUTPUT button or by rear panel ENABLE, or by communication port.			
3. Over -voltage trip point	V	5~176	5~353	5~413	5~717
4. Output under voltage limit (UVL)	---	Preset by front panel or communication port. Prevents from adjusting Vout below limit. Does not affect in analog programming.			
5. Output under voltage protection (UVP)	---	Output shut-down when power supply output voltage goes below UVP programming. User presettable. Reset by AC input recycle in autostart mode or by OUTPUT button or by rear panel ENABLE, or by communication port.			
6. Over temperature protection	---	User selectable, latched or non latched.			

ANALOG PROGRAMMING AND MONITORING					
1. Vout voltage programming	---	0~100%, 0~5V or 0~10V, user selectable. Accuracy and linearity: +/-0.5% of rated Vout.			
2. Iout voltage programming (*13)	---	0~100%, 0~5V or 0~10V, user selectable. Accuracy and linearity: +/-1% of rated Iout.			
3. Vout resistor programming	---	0~100%, 0~5/10Kohm full scale, user selectable. Accuracy and linearity: +/-1% of rated Vout.			
4. Iout resistor programming (*13)	---	0~100%, 0~5/10Kohm full scale, user selectable. Accuracy and linearity: +/-1.5% of rated Iout.			
5. Shut Off (SO) control	---	By electrical Voltage: 0~0.6V/4~15V or dry contact, user selectable logic.			
6. Output current monitor (*13)	---	0~5V or 0~10V, user selectable. Accuracy: +/-1%.			
7. Output voltage monitor	---	0~5V or 0~10V, user selectable. Accuracy: +/-1%.			
8. Power supply OK signal	---	4~5V-OK, 0V-Fail. 500ohm series resistance.			
9. Parallel operation (*8)	---	Possible, up to 6 units in master/slave mode with single wire current balance connection.			
10. Series operation	---	2 identical units (with external diodes). 650VDC MAX. From chassis to ground			
11. CV/CC indicator	---	Open collector. CC mode: On, CV mode: Off. Maximum voltage: 30V, maximum sink current: 10mA			
12. Interlock (ILC) control	---	Enables/Disables the PS output by dry contact (Short: On, Open: Off, Source current: less than 0.5mA). Ena/Dis is activated by front panel.			
13. Local/Remote mode Control	---	By electrical signal or Open/Short: 0~0.6V or short: Remote, 2~15V or open: Local			
14. Local/Remote mode Indicator	---	Open collector (shunted by 36V zener). On (0~0.6V, 10mA sink current max.)-Remote. Off-Local (30V max.).			
15. Trigger out	---	Maximum low level output =0.8V, Minimum high level output =3.8V, Maximum high level output =5V, Maximum source current =16mA, pulse =20μs Typical.			
16. Trigger in	---	Maximum low level input =1.2V, Minimum high level input =3.5V, Maximum high level input =5V, Maximum sink current =16mA, positive edge, trigger: tw =10μs minimum, Tr/Tf =1μs maximum.			
17. Programmed signal 1	---	Open collector, maximum voltage 25V, maximum sink current 100mA. (Shunted by 27V zener)			
18. Programmed signal 2	---	Open collector, maximum voltage 25V, maximum sink current 100mA. (Shunted by 27V zener)			



FRONT PANEL		
1. Control functions	---	Multiple options with 2 Encoders
	---	Vout/Iout manual adjust
	---	OVP/UVL/UVP manual adjust
	---	Protection Functions - OVP, UVL, UVP, Foldback, OCP, INT, SO
	---	Communication Functions - Selection of LAN, IEEE (*16), RS232, RS485, USB
	---	Communication Functions - Selection of Baud Rate, Address
	---	Analog Control Functions - Selection Voltage/resistive programming, 5V/10V, 5K/10K programming
2. Display	---	Vout: 4 digits, accuracy: 0.5% of rated output voltage +/- 1 count.
	---	Iout: 4 digits, accuracy: 0.5% of rated output current +/- 1 count.
3. Indications	---	GREEN LEDs: FINE, MENU, PREV, PROT, REM, OUTPUT, CV, CC
4. Function buttons	---	RED LED: PROT (OVP, UVP, OTP, FOLD, AC FAIL).
	---	FINE, MENU, PREV, PROT, REM, OUTPUT

PROGRAMMING AND READBACK (RS232/485, USB, Optional: IEEE (*16), LAN)		
1. Vout programming accuracy	---	0.05% of actual + 0.05% of rated output voltage
2. Iout programming accuracy (*13)	---	0.2% of rated output current
3. Vout programming resolution	---	0.012% of full scale
4. Iout programming resolution	---	0.012% of full scale
5. Vout readback accuracy	---	0.05% of actual + 0.05% of rated output voltage
6. Iout readback accuracy (*13)	---	0.1% of actual + 0.3% of rated output current
7. Vout readback resolution	---	0.012% of full scale
8. Iout readback resolution	---	0.012% of full scale

INPUT CHARACTERISTICS					
1. Input voltage/freq. (*3)	---	160-5	320-2.5	375-2.2	650-1.25
2. Maximum Input current 100/200VAC (*4)	---	9.35/4.61	9.35/4.59	9.58/4.7	9.44/4.64
3. Power Factor (Typ)	---	0.99 at 100Vac, 0.98 at 200Vac, 100% load			
4. Efficiency (Typ) 100/200VAC (*4)	%	86.5/88.5	86.5/89	87.5/89.5	87/89
5. Inrush current 100/200VAC (*5)	---	Less than 30A			

ENVIRONMENTAL CONDITIONS		
1. Operating temperature	---	0~50°C, 100% load.
2. Storage temperature	---	-20~85°C
3. Operating humidity	%	20~90% RH (no condensation).
4. Storage humidity	%	10~95% RH (no condensation).
5. Altitude	---	Maximum 3000m. Derate ambient temp above 2000m. Operating: Maximum ambient temperature, From 2000m up to 3000m Ambient temperature 40°C.

SAFETY/EMC			
1. Applicable standards:	Safety	---	UL61010-1, EN61010-1, IEC61010-1. Built to meet UL60950-1, EN60950-1 160V≤Vout≤650V: Output, J1, J2 are Hazardous. J3, J4, USB, IEEE/ISOLATED ANALOG, LAN are Non Hazardous
	EMC	---	IEC/EN61326-1 (Built to meet EN55022/EN55024)
2. Interface classification			Output floating: Output, J1, J2 are Hazardous; J3, J4, USB, LAN, IEEE/ISOLATED ANALOG are Non Hazardous
			Vout≤400V, +Output grounded: Output, J1, J2 are Hazardous; J3, J4, USB, LAN, IEEE/ISOLATED ANALOG are Non Hazardous
3. Withstand voltage			Vout>400V, +Output grounded: Output, J1, J2, J3, J4, USB, LAN, IEEE/ISOLATED ANALOG are Hazardous
			160≤Vout≤320V models: Input-Output&J1, J2: 2970VDC/1min; Input-Ground: 2828VDC/1min. Output&J1, J2, -Ground: 2000VDC/1min; Output&J1, J2- J3, J4, USB, LAN/IEEE/ISOLATED ANALOG :3200VDC/1min; Input-J3, J4, USB, LAN/IEEE/ISOLATED ANALOG: 4242VDC/1min; J3, J4, USB, LAN/IEEE/ISOLATED ANALOG Input-Ground: 707VDC/1min. 375≤Vout≤650V model: Input-Output&J1, J2: Input-Output&J1, J2: 3704VDC/1min; Input-Ground: 2828VDC/1min. Output&J1, J2, -Ground: 2154VDC/1min for 375VDC, 2780VDC/1min for 65VDC; Output&J1, J2- J3, J4, USB, LAN/IEEE/ISOLATED ANALOG :4244VDC/1min; Input-J3, J4, USB, LAN/IEEE/ISOLATED ANALOG: 4242VDC/1min; J3, J4, USB, LAN/IEEE/ISOLATED ANALOG Input-Ground: 707VDC/1min.
4. Insulation resistance	---	More than 100Mohm at 25°C, 70%RH.	
5. Conducted emission	---	IEC/EN61326-1 Industrial Location - B, FCC part 15-B, VCCI-B	
6. Radiated emission	---	IEC/EN61326-1 Industrial Location - A, FCC part 15-A, VCCI-A	

MECHANICAL			
1. Cooling	---	Forced air cooling by internal fan.	
2. Weight	STANDARD	Kg	Less than 2Kg
	WIDE BODY	Kg	Less than 2.5Kg. Wide body with isolated analog or IEEE
3. Dimensions (WxHxD)	STANDARD	mm	H: 83, W: 70, D: 350 (excluding bus bars, handles...). (Refer to Outline drawing).
	WIDE BODY	mm	H: 83, W: 105, D: 350 (excluding bus bars, handles...). (Refer to Outline drawing).
4. Vibration	---	According to: IEC60068-2-64	
5. Shock	---	Less than 20G, half sine, 11mS. Unit is unpacked. According to: IEC60068-2-27	

**NOTES:**

- \*1: Minimum voltage is guaranteed to maximum 0.1% of rated output voltage.
- \*2: Minimum current is guaranteed to maximum 0.2% of rated output current.
- \*3: For cases where conformance to various safety standards (UL, IEC, etc...) is required, to be described as 100-240Vac (50/60Hz).
- \*4: Ta=25°C with rated output power.
- \*5: Not including EMI filter inrush current, less than 0.2mSec.
- \*6: At 85~132Vac or 170~265VAC, constant load.
- \*7: From No-Load to Full-Load, constant input voltage. Measured at the sensing point in Remote Sense.
- \*8 For Parallel operation up to 4 units, 5% of total output current is required.  
For Parallel operation more than 4 units, 20% of total output current is required.
- \*9: From 10% to 90% or 90% to 10% of rated output voltage, with rated resistive load.
- \*10: From 90% to 10% of rated output voltage.
- \*11: For load voltage change, equal to the unit voltage rating, constant input voltage.
- \*12: Ripple is measured at 10~100% of rated output voltage and rated output current.
- \*13: The Constant Current programming, readback and monitoring accuracy do not include the warm-up and Load regulation thermal drift.
- \*14: Measured with 10:1 probe.
- \*15: At rated output power.
- \*16 Max. ambient temperature for using IEEE is 45°C.
- \*17: start in low ambient temp. (0°C), 1 min. warm up is required

2.6 Z200W/400W/600W/800W Outline Drawing

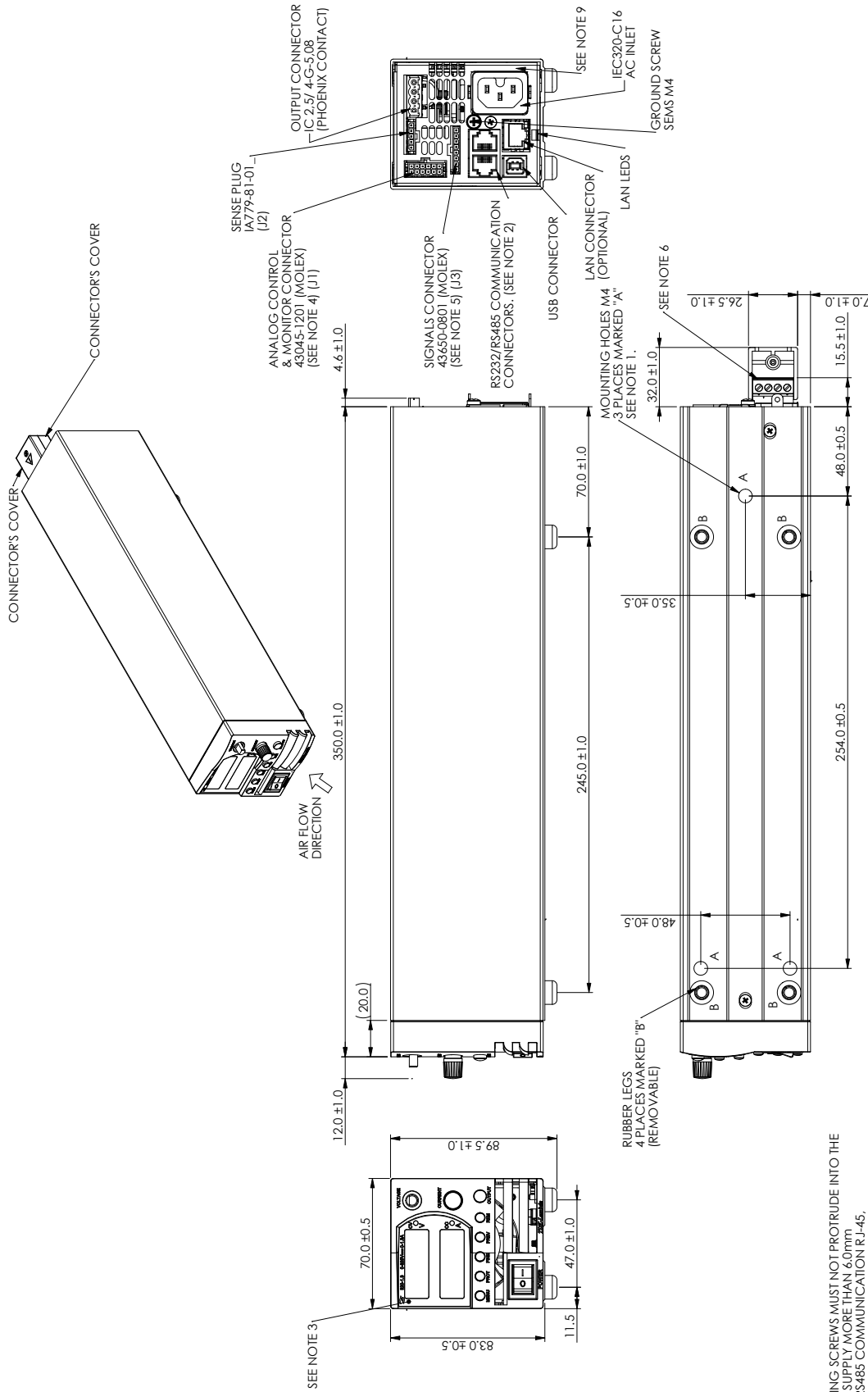

- NOTE
1. MOUNTING SCREWS MUST NOT PROTRUDE INTO THE POWER SUPPLY MORE THAN 6.0mm.
  2. RS232/RS485 COMMUNICATION R/L-45 SHIELDED & CONTACTS CONNECTORS.
  3. MODEL NAME AND OUTPUT RATING SHOWN HERE ACCORDING TO THE SPECIFICATION.
  4. RECEPTACLE MOLEX 43025-1208 CONTACT PIN MOLEX 43030-0002 HAND TOOL: 63819-0000 WIRE AWG: 20-24.
  5. RECEPTACLE MOLEX 43645-0800 CONTACT PIN MOLEX 43030-0002 HAND TOOL: 63819-0000 WIRE AWG: 20-24.
  6. RECEPTACLE PHOENIX CONTACT IC 2 5 / 4 ST-5 08 WIRE AWG: 16-24. (OUTPUT PLUG IA779-81-03.)

### 2.7 Z200W/400W/600W/800W Optional IEEE, Isolated Analog Interface, Front Panel insulated Output sockets

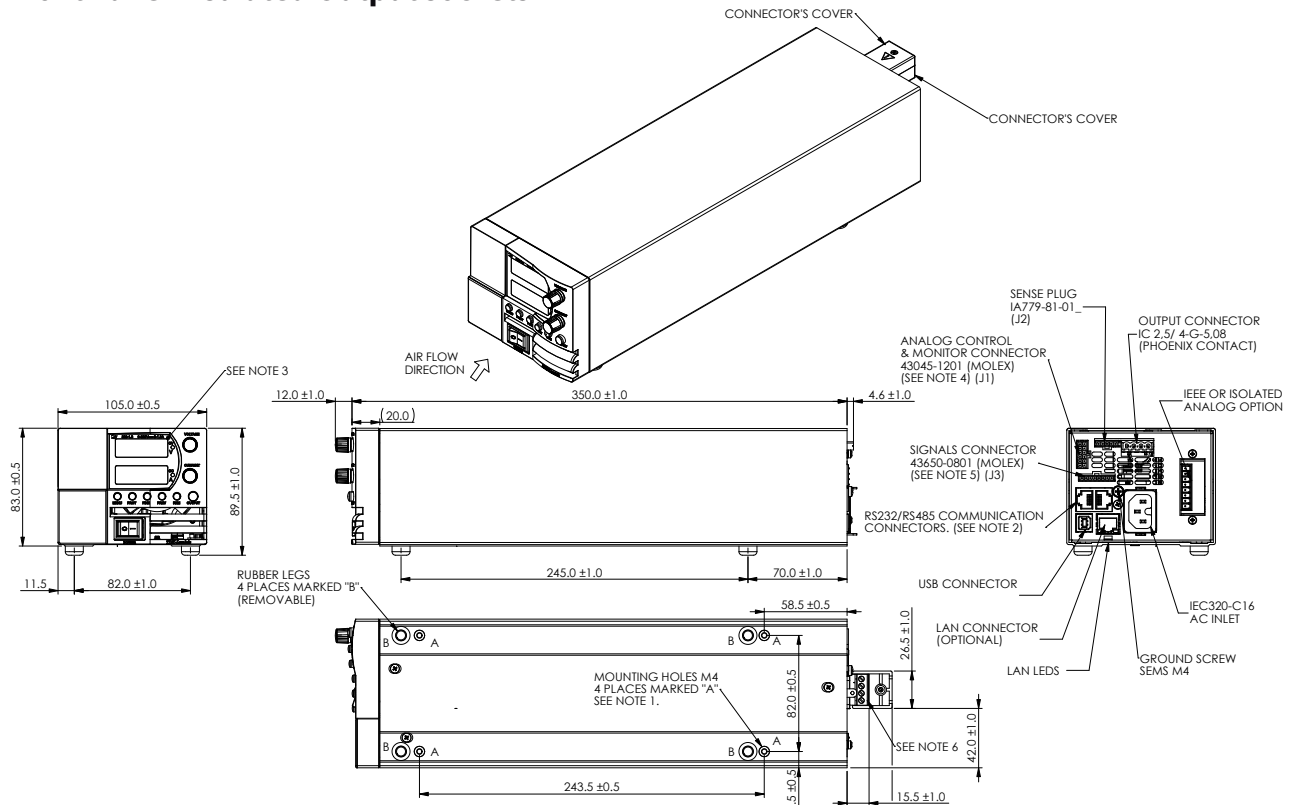

SCREWS MUST NOT PROTRUDE INTO THE  
 \*PLY MORE THAN 6.0mm  
 5 COMMUNICATION RJ-45,  
 CONTACTS CONNECTORS.  
 ME AND OUTPUT RATING SHOWN HERE ACCORDING  
 TO SPECIFICATION:  
 \*E MOLEX 43025-1208  
 \*IN MOLEX 43030-0002  
 \*L 63819-0000 WIRE AWG: 20-24.  
 \*LE MOLEX 43645-0800  
 \*IN MOLEX 43030-0002  
 \*L 63819-0000 WIRE AWG: 20-24.  
 \*LE PHOENIX CONTACT IC 2.5/ 4-ST-5.08  
 : 16-24. (OUTPUT PLUG - IA779-81-03.)

### 19" Rack Housing for Z\*200W/400W/600W/800W

