

PRT1-SCU11

PROFIBUS-DP Gateway to Host Link/Compoway-F

OPERATION MANUAL

OMRON

PRT1-SCU11 PROFIBUS DP Gateway



Operation Manual

Revised September 19, 2005

Notice:

OMRON products are manufactured for use by a trained operator and only for the purposes described in this manual.

The following conventions are used to classify and explain the precautions in this manual. Always heed the information provided with them.

-  **DANGER** Indicates information that, if not heeded, is likely to result in serious injury or loss of life.
-  **WARNING** Indicates information that, if not heeded, could possibly result in serious injury or loss of life.
-  **Caution** Indicates information that, if not heeded, could possibly result in minor or relatively serious injury, damage to the product or faulty operation.

OMRON Product References

All OMRON products are capitalized in this manual. The first letter of the word *Unit* is also capitalized when it refers to an OMRON product, regardless of whether it appears in the proper name of the product.

The abbreviation *Ch* appears in some displays and on some OMRON products. It often means *word* and is abbreviated as *Wd* in the documentation.

The abbreviation *PLC* means Programmable Logic Controller.

Visual Aids

The following headings appear in the left column of the manual to help you locate different types of information.

Note Indicates information of particular interest for efficient and convenient operation of the product.

1, 2, 3...Indicates various lists such as procedures, checklists etc.

Trademarks and Copyrights

PROFIBUS, PROFIBUS FMS, PROFIBUS DP, and PROFIBUS PA are trademarks of PROFIBUS International.

Microsoft, Windows, Windows NT, Windows 2000, Windows XP, Windows Explorer and ActiveX are trademarks of Microsoft Corporation.

Other product names and company names in this manual are trademarks or registered trademarks of their respective companies.

The copyright of the PRT1-SCU11 PROFIBUS DP Gateway belongs to OMRON Corporation.

© OMRON, 2005

All rights reserved. No part of this publication may be reproduced, stored in a retrieval system, or transmitted, in any form, or by any means, mechanical, electronic, photocopying, recording, or otherwise, without the prior written permission of OMRON.

No patent liability is assumed with respect to the use of the information contained herein. Moreover, because OMRON is constantly striving to improve its high-quality products, the information contained in this manual is subject to change without notice. Every precaution has been taken in the preparation of this manual. Nevertheless, OMRON assumes no responsibility for errors or omissions. Neither is any liability assumed for damages resulting from the use of the information contained in this publication.

TABLE OF CONTENTS

About this Manual	ix
PRECAUTIONS	xi
1 Intended Audience	xii
2 General Precautions	xii
3 Safety Precautions	xii
4 Operating Environment Precautions	xiii
5 Application Precautions	xiii
6 Conformance to EC Directives	xv
SECTION 1	
Features and Specifications	1
1-1 Overview of PROFIBUS	2
1-2 PROFIBUS DP Network configuration	6
1-3 PROFIBUS DP Gateway	8
1-4 Basic Operating Procedure	14
SECTION 2	
Installation and Wiring	17
2-1 Unit Components	18
2-2 Installing the PRT1-SCU11 PROFIBUS DP Gateway	23
2-3 Wiring the RS-422A / RS-485 Devices	24
2-4 Initial Setup Procedure	30
2-5 Setting up a PROFIBUS Network	31
2-6 Configuring the PROFIBUS DP network	35
SECTION 3	
Operation	39
3-1 Introduction	40
3-2 PROFIBUS Communication	40
3-3 Compoway-F Communication	41
3-4 K-Format Communication	48
3-5 Host Link Communication	50
3-6 Memobus Communication	51
3-7 PROFIBUS Diagnostics	53
3-8 Auxiliary RS-232C interface	54

TABLE OF CONTENTS

SECTION 4

Troubleshooting and Maintenance 57

4-1	Overview	58
4-2	Troubleshooting Using LED Indicators.	58
4-3	Maintenance.	60
4-4	Replacing the Unit.	61

Appendices

A	Memory Mapping	63
B	Function Block Programming	67

Index. 75

Revision History 79

About this Manual

This manual describes the PRT1-SCU11 PROFIBUS DP Gateway, how to install it and how and operate the Unit. The Unit version number on the side case of the housing indicates supported functionality. If no version number is shown, the version number is 1.0. The following table lists the functions supported per version number.

Unit name	Unit Version	Protocols supported
PRT1-SCU11	1.0	Compoway-F Host Link
	2.0	Compoway-F Host Link K-Format protocol Memobus

Unit version 2.0 includes the same functions as Unit version 1.0, in addition to new protocols supported. Unit version 2.0 will eventually replace Unit version 1.0.

Note This manual describes the features and functions of Unit version 2.0.

Please read this manual carefully so that you understand the information provided before installing or using the PRT1-SCU11 PROFIBUS DP Gateway. Start with the precautions in the following section. They describe the operating environment and application safety measures which must be observed prior to and when using the PRT1-SCU11 PROFIBUS DP Gateway.

The sections of this manual are as follows:

Section 1 introduces the PRT1-SCU11 PROFIBUS DP Gateway.

Section 2 describes the installation and setup of the PRT1-SCU11 PROFIBUS DP Gateway.

Section 3 describes operational aspects of the PRT1-SCU11 PROFIBUS DP Gateway.

Section 4 provides procedures for troubleshooting the PRT1-SCU11 PROFIBUS DP Gateway.

The **Appendices** contain information supplementary to the information in the main body of the manual. They are referred to in the various sections as required.

Manual	Products	Contents	Cat. No.
CS/CJ Series PROFIBUS DP Master Units Operation Manual	SYSMAC CS1/CJ1W-PRM21	Describes the Installation and Operation of the CS1/CJ1W-PRM21 PROFIBUS DP Master Units and CX-Profibus Configurator.	W409-E2-□
E5GN Temperature Controller User manual	E5GN Temperature Controller	Describes the Installation and Operation of the E5GN Temperature Controller.	H101-E1-□
E5EN Temperature Controller User manual	E5EN Temperature Controller	Describes the Installation and Operation of the E5EN Temperature Controller.	H111-E1-□
E5AN Temperature Controller User manual	E5AN Temperature Controller	Describes the Installation and Operation of the E5AN Temperature Controller.	H112-E1-□
E5CN Temperature Controller User manual	E5CN Temperature Controller	Describes the Installation and Operation of the E5CN Digital Temperature Controller.	H129-E1-□

Manual	Products	Contents	Cat. No.
E5□N Communication Functions User manual	E5AN/E5EN/E5CN/E5GN Temperature Controllers	Describes the Compoway-F Communication Functions for the E5AN/E5EN/E5CN/E5GN Temperature Controllers.	H102-E1-□ H130-E1-□
E5ZN Temperature Controller User manual	E5ZN Temperature Controller	Describes the Installation and Operation of the E5ZN Temperature Controller.	H113-E1-□
E5AR/E5ER Digital Controller Users Manual	E5AR/E5ER Digital Controller	Describes the Installation and Operation of the E5AR/E5ER Digital Controllers.	Z182-E1-□
E5□K Communication Functions User manual	E5AK/E5EK Process Controllers	Describes the Installation and Operation of the E5AK/E5EK Intelligent Digital Controller.	H083-E1-□ H085-E1-□
R88A-MCW151-E / R88A-MCW151-DRT-E Motion Control Option Board Operation Manual	R88A-MCW151-E / R88A-MCW151-DRT-E Motion Control Option Board	Describes the Installation and Operation of the R88A-MCW151-E / R88A-MCW151-DRT-E Motion Control Option Board.	I203-E2-□
VARISPEED F7 Vector Control Frequency Inverter User's Manual	OMRON-Yaskawa VARISPEED F7 Inverter	Describes the Installation and Operation of the OMRON-Yaskawa VARISPEED F7 Inverter.	YEG-TOE-S616-55.1-OY

 **WARNING** Failure to read and understand the information provided in this manual may result in personal injury or death, damage to the product, or product failure. Please read each section in its entirety and be sure you understand the information provided in the section and related sections before attempting any of the procedures or operations given.

PRECAUTIONS

This section provides general precautions for using the PRT1-SCU11 PROFIBUS DP Gateway modules, Programmable Controllers and related devices.

The information contained in this section is important for the safe and reliable operation of the PRT1-SCU11 PROFIBUS DP Gateway. You must read this section and understand the information contained before attempting to set up or operate a PROFIBUS DP Gateway system.

1	Intended Audience	xii
2	General Precautions	xii
3	Safety Precautions	xii
4	Operating Environment Precautions	xiii
5	Application Precautions	xiii
6	Conformance to EC Directives	xv
6-1	Applicable Directives	xv
6-2	Concepts	xv
6-3	Conformance to EC Directives	xv

1 Intended Audience

This manual is intended for the following personnel, who must also have a knowledge of electrical systems (an electrical engineer or the equivalent).

- Personnel in charge of installing FA systems.
- Personnel in charge of designing FA systems.
- Personnel in charge of managing FA systems and facilities.

2 General Precautions

The user must operate the product according to the performance specifications described in the operation manuals.

Before using the product under conditions which are not described in the manual or applying the product to nuclear control systems, railroad systems, aviation systems, vehicles, combustion systems, medical equipment, amusement machines, safety equipment, and other systems, machines, and equipment that may have a serious influence on lives and property if used improperly, consult your OMRON representative.

Make sure that the ratings and performance characteristics of the product are sufficient for the systems, machines, and equipment, and be sure to provide the systems, machines, and equipment with double safety mechanisms.

This manual provides information for programming and operating OMRON PROFIBUS DP Gateway. Be sure to read this manual before attempting to use the Unit and keep this manual close at hand for reference during operation.

 **WARNING** It is extremely important that the Unit is used for its specified purpose and under the specified conditions, especially in applications that can directly or indirectly affect human life. You must consult your OMRON representative before using it in a system in the above-mentioned applications.

3 Safety Precautions

 **WARNING** Do not attempt to take any Unit apart while the power is being supplied. Doing so may result in electric shock.

 **WARNING** Never touch any of the terminals while power is being supplied. Doing so may result in serious electrical shock or electrocution.

 **WARNING** Do not attempt to disassemble, repair, or modify any of the Units. Any attempt to do so may result in malfunction, fire, or electric shock.

4 Operating Environment Precautions

 **Caution** Do not operate the Unit in the following places:

- Locations subject to direct sunlight.
- Locations subject to temperatures or humidities outside the range specified in the specifications.
- Locations subject to condensation as the result of severe changes in temperature.
- Locations subject to corrosive or flammable gases.
- Locations subject to dust (especially iron dust) or salt.
- Locations subject to exposure to water, oil, or chemicals.
- Locations subject to shock or vibration.

Provide proper shielding when installing in the following locations:

- Locations subject to static electricity or other sources of noise.
- Locations subject to strong electromagnetic fields.
- Locations subject to possible exposure to radiation.
- Locations near to power supply lines.

 **Caution** The operating environment of the PROFIBUS DP Gateway can have a large effect on the longevity and reliability of the system. Unsuitable operating environments can lead to malfunction, failure and other unforeseeable problems with the system. Ensure that the operating environment is within the specified conditions at installation time and remains that way during the life of the system. Follow all installation instructions and precautions provided in the operation manuals.

5 Application Precautions

Observe the following precautions when using the PROFIBUS DP Gateway.

 **WARNING** Failure to abide by the following precautions could lead to serious or possibly fatal injury. Always heed these precautions.

- Always connect to a class-3 ground (100 Ω or less) when installing the Units.

 **Caution** Failure to abide by the following precautions could lead to faulty operation of the Unit or the system or could damage the Unit or Temperature Controllers and R88A-MCW151-E. Always heed these precautions.

- Install double safety mechanisms to ensure safety against incorrect signals that may be produced by broken signal lines or momentary power interruptions.
- When adding a new device to the network, make sure that the baud rate is the same as other nodes.

- When adding a new Host Link or Compoway-F node to the network, make sure that the PROFIBUS DP Gateway is powered down, to prevent unexpected results when starting up the new node.
- Use specified communications cables.
- Do not extend connection distances beyond the ranges given in the specifications.
- Always turn OFF the power supply to the personal computer, Slaves, and Communications Units before attempting any of the following.
 - Mounting or dismounting the PROFIBUS DP Gateway, Power Supply Units, I/O Units, CPU Units, or any other Units.
 - Assembling a Unit.
 - Setting DIP-switches or rotary switches.
 - Connecting or wiring the cables.
 - Connecting or disconnecting connectors.
- Be sure that all the mounting screws, terminal screws, Unit mounting screws, and cable connector screws are tightened to the torque specified in the relevant manuals. Incorrect tightening torque may result in malfunction.
- Leave the label attached to the Unit when wiring. Removing the label may result in malfunction if foreign matter enters the Unit.
- Remove the label after the completion of wiring to ensure proper heat dissipation. Leaving the label attached may result in malfunction.
- Always use the power supply voltage specified in this manual.
- Double-check all the wiring and connection of terminal blocks and connectors before mounting the Units.
- Use crimp terminals for wiring. Do not connect bare stranded wires directly to terminals.
- Observe the following precautions when wiring the communications cable.
 - Separate the communications cables from the power lines or high-tension lines.
 - Do not bend the communications cables.
 - Do not pull on the communications cables.
 - Do not place heavy objects on top of the communications cables.
 - Be sure to wire communications cable inside ducts.
 - Use appropriate communications cables.
- Take appropriate measures to ensure that the specified power with the rated voltage and frequency is supplied in places where the power supply is unstable. An incorrect power supply may result in malfunction.
- Install external breakers and take other safety measures against short-circuits in external wiring. Insufficient safety measures against short-circuits may result in burning.
- Double-check all the wiring and switch settings before turning ON the power supply.
- When transporting or storing the product, cover the PCB's with electrically conductive materials to prevent LSI's and IC's from being damaged by static electricity, and also keep the product within the specified storage temperature range.

- When transporting the Unit, use special packing boxes and protect it from being exposed to excessive vibration or impacts during transportation.
- Do not attempt to disassemble, repair, or modify any Units.

6 Conformance to EC Directives

6-1 Applicable Directives

- EMC Directives
- Low voltage directive

6-2 Concepts

OMRON units complying with EC Directives also conform to related product standards making them easier to incorporate in other units or machines. The actual products have been checked for conformity to product standards. Whether the products conform to the standards in the system used by the customer, however, must be checked by the customer.

Product related performance of OMRON units complying with EC Directives will vary depending on the configuration, wiring, and other conditions of the equipment or control panel in which OMRON devices are installed. The customer must, therefore, perform final checks to confirm that units and the overall system conforms to product standards.

A Declaration of Conformity for the PROFIBUS DP Gateway can be requested at your nearest OMRON representative.

6-3 Conformance to EC Directives

PROFIBUS units should be installed as follows, for the complete configuration to meet the EC directives:

- 1,2,3...**
1. The units are designed for installation inside control panels. All units must be installed within control panels.
 2. Use reinforced insulation or double insulation for the DC power supplies used for the communications power supply, internal circuit power supply, and the I/O power supplies.
 3. The PROFIBUS DP Gateway product meets the generic emission standard. However as EMC performance can vary in the final installation, additional measures may be required to meet the standards. It should therefore be verified that the overall machine or device also meets the relevant standards. You must therefore confirm that EC directives are met for the overall machine or device, particularly for the radiated emission requirement (10 m).

SECTION 1

Features and Specifications

This section provides an introductory overview of PROFIBUS, its functions and how to setup and configure a network. It also addresses the PRT1-SCU11 PROFIBUS DP Gateways and the Configurator, their features and specifications.

1-1	Overview of PROFIBUS	2
1-1-1	Introduction	2
1-1-2	PROFIBUS Communication Protocol	2
1-1-3	Device Types	4
1-1-4	Bus Access Protocol	4
1-1-5	Diagnostic functions	5
1-1-6	Protection mechanisms	5
1-1-7	Network Operation Modes	6
1-2	PROFIBUS DP Network configuration	6
1-3	PROFIBUS DP Gateway	8
1-3-1	PROFIBUS DP Gateway Features	8
1-3-2	Specifications	10
1-4	Basic Operating Procedure	14
1-4-1	Overview	14
1-4-2	Procedures Prior to Starting Communications	15

1-1 Overview of PROFIBUS

1-1-1 Introduction

Standard EN50170



PROFIBUS (PROcess FieldBUS) is an open fieldbus standard for a wide range of applications in manufacturing, processing and building automation. The Standard, EN 50170 (the Euronorm for field communications), to which PROFIBUS adheres, guarantees vendor independence and transparency of operation. It enables devices of various manufacturers to intercommunicate without having to make any special interface adaptations.

The PROFIBUS family comprises three mutually compatible versions: PROFIBUS FMS, PROFIBUS DP and PROFIBUS PA.

PROFIBUS FMS

FMS means Fieldbus Message Specification. This version is the general-purpose solution for high-level extensive and complex communication tasks. Powerful services open up a wide range of applications and provide great flexibility.

PROFIBUS DP

DP means Decentralized Periphery. PROFIBUS DP is optimized for high speed and low-cost interfacing. It is specially designed for communication between automation control systems and distributed I/O at the device level.

PROFIBUS PA

PA means Process Automation. It permits sensors and actuators to be connected to one common bus even in areas where intrinsically safe products are required. It also permits data and power to be supplied over the bus using 2-wire technology according the international standard IEC 1158-2.

Uniform Bus Access Protocol

PROFIBUS DP and PROFIBUS FMS use the same transmission technology and uniform bus access protocol. Consequently, both versions can be operated simultaneously on the same bus. FMS field devices, however, cannot be controlled by DP masters and vice versa.

 **Caution** It is not possible to exchange one of these family members by another family member. This will cause faulty operation.

The rest of this section describes the PROFIBUS DP Protocol architecture.

1-1-2 PROFIBUS Communication Protocol

OSI reference model

ISO-7498

In general, the PROFIBUS communication protocol is based on the Open System Interconnection (OSI) reference model in accordance with the international standard ISO-7498 (see the following illustration). The model defines 7 layers of communication functions, three of which - layers 1, 2, and 7 - are used in PROFIBUS.

- Layer 1, the Physical Layer of this model, defines the physical transmission characteristics.
- Layer 2, the Data Link Layer of this model, defines the bus access protocol. This protocol also includes data security and the handling of transmission protocols and telegrams.
- Layer 7, the Application Layer of this model, defines the application functions. This Layer is only applicable to PROFIBUS FMS.

User Interface Layer
 (7) Application Layer
 (6) Presentation Layer
 (5) Session Layer
 (4) Transport Layer
 (3) Network Layer
 (2) Data Link Layer
 (1) Physical Layer

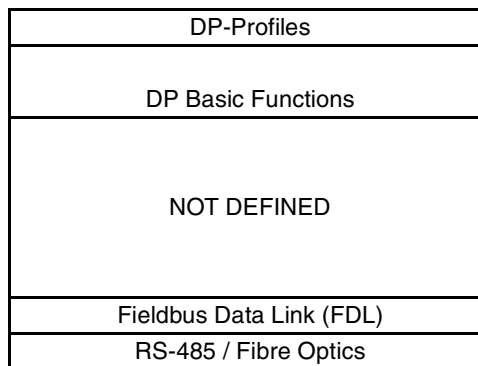

OSI Layer 1, 2 and User Interface

PROFIBUS DP uses layers 1 and 2, and the user interface. Layers 3 to 7 are not defined for PROFIBUS DP. The user interface Layer defines the interface functions for specific application areas, i.e. the PROFIBUS DP basic functions and communication profiles. This streamlined architecture ensures fast and efficient data transmission. The application functions which are available to the user, as well as the system and device behaviour of the various PROFIBUS DP device types, are specified in the user interface.

OSI Layer 1: Transmission Medium

RS-485 transmission technology or fibre optics are available for transmission. RS-485 transmission is the most frequently used transmission technology. Its application area includes all areas in which high transmission speed and simple inexpensive installation are required. PROFIBUS modules are interconnected by single twisted-pair shielded copper wires.

RS-485 Technology

The RS-485 transmission technology is very easy to handle. Installation of the twisted pair cable does not require expert knowledge. The bus structure permits addition and removal of devices or step-by-step commissioning of the system without influencing the other devices. Later expansions have no effect on devices which are already in operation.

RS-485 Transmission Speed

Transmission speeds between 9.6 kbit/s and 12 Mbit/s can be selected as shown in the table below. One unique transmission speed must be selected for all devices on the bus (master and slave devices) when the system is commissioned

Baud rate (kbit/s)	Distance / segment (m)
9.6	1200
19.2	1200
45.45	1200
93.75	1200
187.5	1000
500	400
1500	200
3000	100
6000	100
12000	100

Cable length

The maximum cable length values depend on the transmission speed and are based on type-A cable (see *Bus Cable Connector* on page 34). The length can be increased by the use of repeaters. However, it is not recommended to use more than three repeaters in series in a PROFIBUS network.

1-1-3 Device Types

PROFIBUS distinguishes between master devices and slave devices.

Master Devices

Master devices determine the data communication on the bus. A Master can send messages without an external request, as long as it holds the bus access right (the token). Masters are also referred to as active devices in the PROFIBUS standard.

There are two types of master devices:

Class 1 Master (DPM1)

A PROFIBUS DP Class 1 Master (DPM1) device is a central controller, which exchanges information with the decentralized devices (i.e. DP slaves) within a specified message cycle.

Class 2 Master (DPM2)

PROFIBUS DP class 2 Master (DPM2) devices are programmers, configuration devices or operator panels. They are used during commissioning, for configuration of the DP system, or for operation and monitoring purposes.

Slave Devices

Slave devices are peripheral devices. Typical slave devices include input/output devices, valves, drives, and measuring transmitters. They do not have bus access rights and they can only acknowledge received messages or send messages to the master when requested to do so. Slave devices are also called passive devices. The PRT1-SCU11 is a slave device.

Device Profile

To enable the exchange of devices from different vendors, the user data has to have the same format. The PROFIBUS DP protocol does not define the format of user data, it is only responsible for the transmission of this data. The format of user data may be defined in so called profiles. Profiles can reduce engineering costs since the meaning of application-related parameters is specified precisely. Profiles have been defined for specific areas like drive technology, encoders, and for sensors / actuators.

1-1-4 Bus Access Protocol

OSI Layer 2: Bus Access Protocol

The PROFIBUS bus access protocol is implemented by OSI layer 2. This protocol also includes data security and the handling of the transmission protocols and messages.

Medium Access Control

The Medium Access Control (MAC) specifies the procedures which determine when a device is permitted to transmit data. A token passing procedure is used to handle the bus access between master devices, and a polling procedure is used to handle the communication between a master device and its assigned slave device(s).

Token Passing

The token passing procedure guarantees that the bus access right (the token) is assigned to each master within a precisely defined time frame. The token message, a special message for passing access rights from one master to the next master, must be passed around the logical token ring - once to each master - within a specified target rotation time. Each master executes this procedure automatically.

Polling Procedure

The polling or master-slave procedure permits the master, currently in possession of the token, to access its assigned slaves. The figure below shows a possible configuration. The configuration shows three active devices (masters) and six passive devices (slaves).

The three masters form a logical token ring. When an active device receives the token message, it can perform its master role for a certain period of time. During this time it can communicate with all assigned slave devices in a master-slave communication relationship, and a DPM2 master can take the initia-

tive to communicate with DPM1 master devices in a master-master communication relationship.

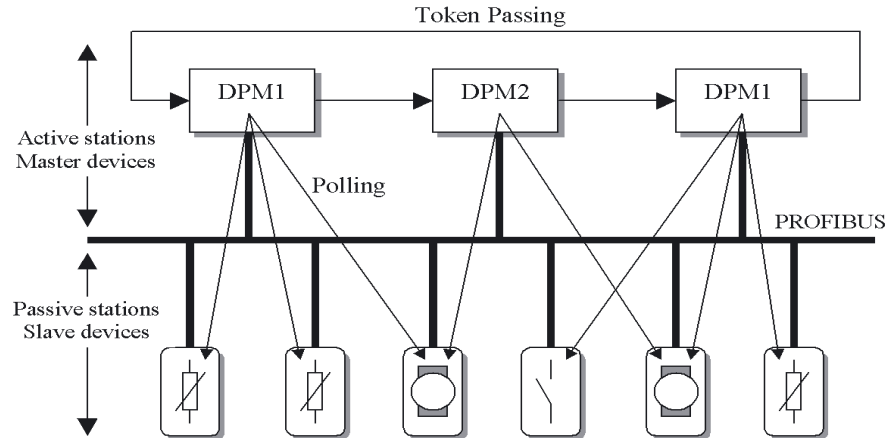

Multi-peer Communication

In addition to logical peer-to-peer data transmission, PROFIBUS DP provides multi-peer communication (broadcast and multicast).

Broadcast Communication

In the case of broadcast communication a master device sends an unacknowledged message to all other devices (masters and slaves).

Multicast Communication

In the case of multicast communication a master device sends an unacknowledged message to a predetermined group of devices (masters and slaves).

1-1-5 Diagnostic functions

Extensive Diagnostics

Extensive diagnostic functions defined in PROFIBUS DP enable the fast location of error at slave devices. Diagnostic messages are transmitted over the bus and collected at the master. Three levels of diagnostic messages are defined:

Device Related Diagnostics

- Messages concerning the general operational status of the whole device, e.g. over temperature, low voltage.

Module Related Diagnostics

- Messages indicating that an error is present in a specific I/O range of a device, e.g. an 8-bit output module.

Channel Related Diagnostics

- Messages indicating an error at a given input or output, e.g. short circuit on Output 5.

1-1-6 Protection mechanisms

Monitoring Time

PROFIBUS DP provides effective protection functions against parameterization errors or failure of the transmission equipment. Time monitoring is provided both at the master and the slave devices. The monitoring interval is specified when the system is configured.

Monitoring at the Master

The PROFIBUS DP Master monitors data transmission of the slaves with the Data-Control-Timer. A separate control timer is used for each slave. This timer expires if response data is not correctly transmitted by the slave within the monitoring interval. The user is informed when this happens. If the automatic error reaction (Auto-CLEAR) has been enabled, the PROFIBUS DP

master exits its OPERATE state, switches the outputs of all assigned slaves to the fail-safe status and changes to the CLEAR state.

Monitoring at the Slave

Slave devices use a watchdog to detect failures of the master or the bus. If data communication with the master does not occur within the set watchdog time interval, a slave automatically switches its outputs to the fail-safe mode.

Also, access protection is provided for the inputs and outputs of the slaves operating in multi-master systems. Only authorized masters can access their slaves.

1-1-7 Network Operation Modes

PROFIBUS DP distinguishes four different network operation modes:

OFF-LINE

Communication with all PROFIBUS DP participants (masters and slaves) is stopped. The Master ceases to access the PROFIBUS network.

STOP

Communication between the master and its slaves is stopped. Only communication between the master and other masters is still possible.

CLEAR

The master tries to set parameters, check the configuration, and perform data exchange with its associated slaves. Data exchange involves reading the inputs of the PROFIBUS DP slaves and writing zeros to the outputs of the slaves.

OPERATE

The master exchanges data with its assigned slaves, inputs are read and outputs are written. Also, the master cyclically sends its local status to all its assigned PROFIBUS DP slaves (using a broadcast message).

Auto-CLEAR

If an error occurs during the data exchange phase of the master, the 'Auto-CLEAR' function determines the subsequent actions. If this function has been disabled, the master remains in the OPERATE mode. If the function has been enabled, the master automatically changes the network to the CLEAR mode, in which the outputs of the assigned PROFIBUS DP slaves are switched to zero, i.e. the 'fail-safe' state. The master continues to read the inputs of the slaves.

Fail-safe State

1-2 PROFIBUS DP Network configuration

In order to operate a PROFIBUS network, each master in the network needs to be configured. This process of PROFIBUS Master configuration involves:

- setting up the network topology, i.e. assigning the slave devices with which the master will be exchanging data,
- defining the parameterization data, which the master will send to each of the slave devices, before process data exchange can commence
- defining the configuration data, i.e. defining the process data, which will be exchanged,
- setting up the bus parameters, which define the baud rate and the bus timing parameters.
- downloading the configuration setup to the master device.

Configuration Technology

The configuration process is usually facilitated by a special Computer based program, often referred to as a Configurator. The Configurator requires special configuration files, defining the configuration options for each device, which is to participate in data exchange. The files must be provided by the manufacturer of the device.

Two types of configuration technology exist:

- Configuration technology based on FDT/DTM technology
- Configuration technology based on GSD-files

FDT/DTM Concept

The FDT/DTM concept specifies the interfaces between the engineering systems called Field Device Tools (FDT), and the device-specific software components called Device Type Managers (DTM).

The FDT/DTM concept separates the device dependent functionality (which is in the DTM) from the application. It provides separate interfaces for device configuration, monitoring and maintenance solutions, which before largely depended on the manufacturer of the application. Because of this concept, FDT/DTM technology is not limited to PROFIBUS applications. In concept, any type of network can be configured and accessed, provided the appropriate DTM's are available.

CX-Profibus is an example of a FDT container application. It is described in detail in the following sections.

GSD file Technology

The older and most commonly used configuration technology is the based on GSD files (General Slave Data file). A GSD file is a text file, containing the characteristic features and configuration options of a device. The device data base file of each device is loaded in the configurator and downloaded to the master device.

GSD files are usually supplied with a unit, or can be downloaded from the Internet, either from the manufacturer's site, or from the GSD library of the PROFIBUS Nutzer Organisation at <http://www.profibus.com>.

GSD File Language

The language used in the GSD file is indicated by the last letter of the file extension, *.GS?:

- Default = GSD
- English = GSE
- German = GSG
- Italian = GSI
- Portuguese = GSP
- Spanish = GSS

The GSD files are prepared individually by the vendor for each type of device, according to a fixed format. Some parameters are mandatory, some have a default value and some are optional. The device data base file is divided into three parts:

General Section

- General specifications

This section contains the vendor name, the device name, hardware- and software release versions, device type and identification number, protocol specification and supported baud rates.

DP-master Section

- DP master-related specifications

This section contains all parameters which only apply to DP master devices (e.g. maximum memory size for the master parameter set, maximum number of entries in the list of active devices, or the maximum number of slaves the master can handle).

DP-slave Section

- DP slave-related specifications

This section contains all specification related to slaves (e.g. minimum time between two slave poll cycles, specification of the inputs and outputs, and consistency of the I/O data).

1-3 PROFIBUS DP Gateway

1-3-1 PROFIBUS DP Gateway Features

PRT1-SCU11 PROFIBUS DP Gateway

The PRT1-SCU11 is a standalone product, providing an interface between a PROFIBUS DP Master device and the following OMRON units.

Unit	Description	Protocol supported
E5AN / E5CN / E5EN / E5GN	OMRON single channel Temperature controllers.	Compoway-F
E5ZN	OMRON 2-channel Temperature controllers.	
E5AR / E5ER	OMRON 4-channel Temperature controllers.	
E5__ / K3__ / H8GN	OMRON instruments, supporting OMRON's RS-485 based Compoway-F protocol.	
E5AK / E5EK	OMRON Intelligent Digital Controllers	K-Format protocol
R88A-MCW151-E	Option board for W-series servo drives.	Host Link
F7 Inverter	OMRON-Yaskawa Varispeed F7 Inverter.	Memobus

In addition to this functionality, an auxiliary RS-232C interface is provided on the Unit, to provide a direct connection to a Personal Computer. This direct connection links the Personal Computer directly to Compoway-F / K-Format / Memobus protocol, thus bypassing the PROFIBUS DP connection.

Note The PRT1-SCU11 supports only one of the possible protocols at a time. This means that for example a mix of Compoway-F and Host Link devices is not supported.

Typical application setup

A typical application setup for the PRT1-SCU11 is shown in the figure below. The PRT1-SCU11 Unit interfaces between PROFIBUS DP and Host Link, Compoway-F, Memobus and the K-Format protocol.

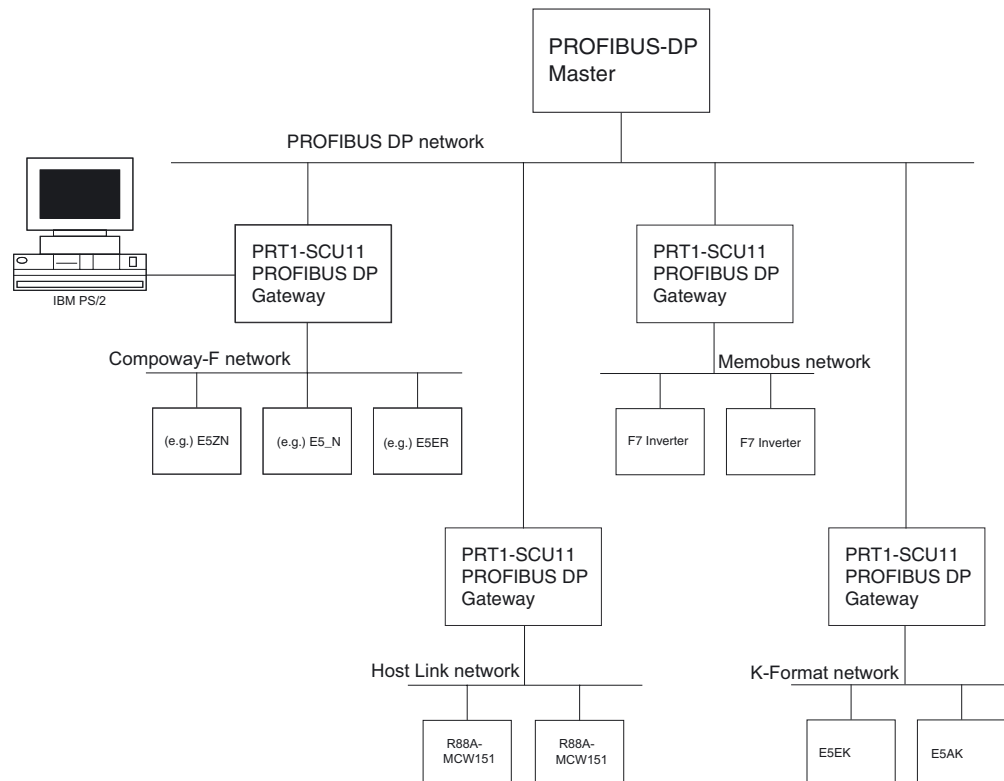

The PRT1-SCU11 is present on the PROFIBUS DP network as a slave unit. The interface of the PRT1-SCU11 is controlled by a Master unit on the network. This Master unit can be any PROFIBUS DP class 1 or class 2 master

Compoway-F	Compoway-F is the OMRON proprietary serial communication bus system, based on RS-485, to communicate with a range of OMRON Temperature Controllers.
K-Format	The K-Format protocol is the OMRON proprietary serial communication bus system, based on either RS-422A or RS-485, to communicate with OMRON's E5AK/E5EK Intelligent Digital Controllers.
Host Link	Host Link is the OMRON proprietary serial communication bus system, based on RS-422A, to communicate with the OMRON/Yaskawa R88A-MCW151-E option board for W-series servo drives.
Memobus	The Memobus protocol is the Omron-Yaskawa variation of the Modbus RTU Protocol used to communicate over either RS-422A or RS-485 with Omron-Yaskawa F7 Inverters.
IBM compatible Personal Computer	An IBM compatible Personal Computer is connected to the PRT1-SCU11 PROFIBUS DP Gateway via a RS-232C serial communication to the auxiliary port. Application programs running on the Personal Computer can communicate through the auxiliary port with Compoway-F, K-Format and Memobus components, thus bypassing the PROFIBUS DP interface. The Host Link protocol is not supported by the Auxiliary port.
I/O Data	The data exchanged over PROFIBUS DP are word sized, and represent either fixed length communication blocks or Free Communication blocks. The PRT1-SCU11 PROFIBUS DP Gateway limits the total number of input words to 100 words, and the total number of output words to 100 words.
Fixed Communication Blocks	<p>Fixed Communication Blocks are I/O modules with predefined parameter content. These modules are to be used to send output and control data to a device and read status from a device. These I/O modules are defined in the PRT1-SCU11 and cannot be changed by the user. They are the most commonly used and straight forward way to exchange data between a Master and one or more of the devices attached to the PRT1-SCU11.</p> <p>In general there are at least two Fixed Communication Blocks defined for each device type or group of devices attached to a PRT1-SCU11. One block is always available for limited I/O data, e.g. setpoint and process value, and one block is available for extended I/O data transfer.</p>
Free Communication Blocks	<p>Free Communications Blocks, are predefined I/O modules, which allow the user to send any read, write or operate instruction to any attached Compoway-F, K-Format or Memobus device without unit interference. The information in the Free Communication Block is used by the PRT1-SCU11 to assemble the correct message format.</p> <p>Three types of Free Communication Blocks are defined, the types are Operate, Read and Write.</p> <ul style="list-style-type: none">• Operate: Execution of a special operation command, which is defined in a controller.• Write: Execution of a write data command to any parameter defined in a controller.• Read: Execution of a read data command of any parameter defined in a controller.

PROFIBUS I/O Data Exchange

The PRT1-SCU11 PROFIBUS DP Gateway supports cyclic Master - Slave communications, i.e. data exchange mode. In data exchange mode the PRT1-SCU11:

- retrieves all data from the attached units (e.g. Compoway-F) according to the PROFIBUS configuration and stores this data in the PROFIBUS input buffer. All input data is obtained before the data is sent to the PROFIBUS Master as input data.
- writes all data from the PROFIBUS outputs to the attached units according to the PROFIBUS configuration, using the proper protocol. Only if the data received from the Master differs from the current value in the units, the new output data is sent.
- sends special operation commands.
- sends command data from Free Communication Blocks to the addressed unit, and returns the command response to the Master as PROFIBUS input data.

Troubleshooting Functions

The PRT1-SCU11 is provided with a variety of troubleshooting functions for prompt recovery in case of errors:

- Extensive self-diagnostic function at startup.
- Diagnostics information is sent to the PROFIBUS Master unit in case:
 - One or more units attached to the PRT1-SCU11 has a communication error.
 - The PRT1-SCU11 has a system error.
- Diagnostics flags, indicating if units attached to the PRT1-SCU11 are functioning correctly. For Host Link there is a communication active bit that indicates to the Host Link Unit if the received PROFIBUS data is valid.

1-3-2 Specifications

General Specifications

The PRT1-SCU11 is a Gateway between PROFIBUS DP and a range of OMRON devices, supporting OMRON proprietary protocols. The Unit version number on the side case of the housing indicates supported protocols. If no version number is shown, the version number is 1.0. The following table lists the protocols supported per version number.

PROFIBUS DP Gateway Model

Model name	Unit Version	Protocol supported
PRT1-SCU11	1.0	Compoway-F Host Link
	2.0	Compoway-F Host Link K-Format Memobus

- Note**
1. Unit version 2.0 includes the same functions as Unit version 1.0, in addition to new protocols supported, and it is backward compatible with Unit version 1.0. Unit version 2.0 will eventually replace Unit version 1.0.
 2. This manual describes all features and functions of Unit version 2.0.

PRT1-SCU11 PROFIBUS DP Gateway Specifications

Item		Specification (Unit version 2.0)
Installation	Model	PRT1-SCU11
	Mounting position	DIN rail mounted
	Power supply	24 Vdc +10% -15% (20.4 to 26.4 Vdc)
	Current consumption	85 mA (max), 75 mA typical at 24 Vdc
	Dimensions (W x H x D)	40 x 90 x 65 mm
	Weight	130g
Environment	Ambient temperatures	Operating temperature: 0 to 55°C Storage temperature: -20 to 75°C
	Ambient operating humidity	10% to 90% (with no condensation)
	Vibration resistance	Conforms to IEC60068-2-6, test Fc. 10 to 55Hz, 0.25-mm amplitude, 55 to 300Hz, acceleration: 29.4 m/s ² in X, Y, and Z directions for 120 minutes each. (Total time: 12 linear sweeps x 10 minutes / sweep = 120 minutes)
	Shock resistance	Conforms to IEC60068-2-27, test Ea. 196 m/s ² three times each in X, Y, and Z directions
	Dielectric strength	600 VAC (between isolated circuits)
	Conformance to EMC and Electrical safety standards	EN61000-6-2: 2001 EN61000-6-4: 2001/CISPR11 EN61131-2: 2003, IDT
Front case	Settings, rotary switches	2 Slave address rotary switches, range: 0 ~ 99 (Decimal)
	Settings DIP-switches	4 DIP-switches on the front of the Unit: <ul style="list-style-type: none"> • Switch 1, Switch 2: Baud rate setting RS-422A / RS-485 communication interface. • Switch 3: not used. • Switch 4: auxiliary RS-232C interface function selector.
	Indicators	6 LED's, indicating Unit status and PROFIBUS status: Unit status: RUN (Green LED) ERR (Red LED) RS-422A/RS-485 protocol: FCOM (Green LED) FERR (Red LED) PROFIBUS status: COMM (Green LED) BF (Red LED)
	PROFIBUS Connector	9-pin sub-D female connector (#4/40 UNC thread).
I/O units + data	Number of GSD I/O Units	15.
	Number of GSD I/O modules	18, maximum number of modules represent 15 units and 1 read, 1 write and 1 operation Free Communication Block. Total sum of all modules must not exceed 18 modules, this includes a maximum of 15 physical units.
	Number of I/O data supported by slave Unit	Up to 100 words input and 100 words output maximum.
	Number of diagnostics data supported by slave Unit	Up to 7 bytes of diagnostics max. per attached unit. Diagnostic data is collected at the attached unit, and is part of the PROFIBUS input/output message.
	Extended diagnostics supported by the slave Unit	The Unit reports system errors and communication errors in a PROFIBUS extended diagnostic message, this message has a length of 7 bytes. After detection of a system error, the data exchange is stopped.

Protocol Specifications

	Item	Specification
Protocol port physical layer	Media types	<ul style="list-style-type: none"> • RS-422A, galvanically isolated. • RS-485, galvanically isolated. Selection for RS-485 is made with Physical layer switch 1 (see 2-1-3 Switch Settings). ON: RS-485 OFF: RS-422A
	termination resistor	Internal 220 Ohm resistor between receiver lines. Use of resistor can be enabled or disabled, using Physical layer switch 2 (see 2-1-3 Switch Settings). ON: Termination resistor enabled. OFF: Termination resistor disabled.
	Connector	5-pin Phoenix connector
	Baud rates supported	<ul style="list-style-type: none"> • 9.6 kbit/s • 19.2 kbit/s • 38.4 kbit/s Selection via DIP-switches 1 and 2. (See 2-1-3 Switch Settings).
	Protocol types supported via this port	<ul style="list-style-type: none"> • Compoway-F • Host Link • K-Format • Memobus
	Device address range	1 ~ 15, set through the slot number of the PROFIBUS module configuration. Number 0 (zero) is reserved.
Auxiliary port	Media type	RS-232C, located behind cover marked "Peripheral" Use the CS1W-CN226 connection cable for connecting the PRT1-SCU11 with Thermotools
	Baud rates supported	Baud rate used on Auxiliary port is the same as the baud rate used on the main protocol port. Selection via DIP-switches 1 and 2. (See 2-1-3 Switch Settings).
	Protocol types supported via this port	<ul style="list-style-type: none"> • Compoway-F • K-Format • Memobus
PROFIBUS DP interface	Applicable standards	EN50170, Volume 2
	Protocol type supported	PROFIBUS DP
	PROFIBUS Unit type	PROFIBUS DP slave
	PROFIBUS Media type	RS-485, galvanically isolated
	PROFIBUS Connector	9-pin sub-D female connector (#4/40 UNC thread) Termination according to EN50170 provided by the cable connector
	Unit device address range	0 ~ 99, set through rotary switches Remote setting not supported.
	Baud rates supported (Auto-detect)	<ul style="list-style-type: none"> • 9.6 kbit/s • 19.2 kbit/s • 45.45 kbit/s • 93.75 kbit/s • 187 kbit/s • 500 kbit/s • 1.5 Mbit/s • 3 Mbit/s • 6 Mbit/s • 12 Mbit/s

Item		Specification
I/O Data	PROFIBUS services supported	<ul style="list-style-type: none"> • Set_Prm • Chk_Cfg • Get_Cfg • Slave_Diag • Data_Exchange • RD_Inp • RD_Outp • Global_Control - Sync / Unsync Freeze / Unfreeze/ Clear
	Number of I/O data supported	Up to 100 words input and 100 words output max.
	Number of diagnostics data supported	6 Bytes basic, and 9 bytes extended.

External Dimensions

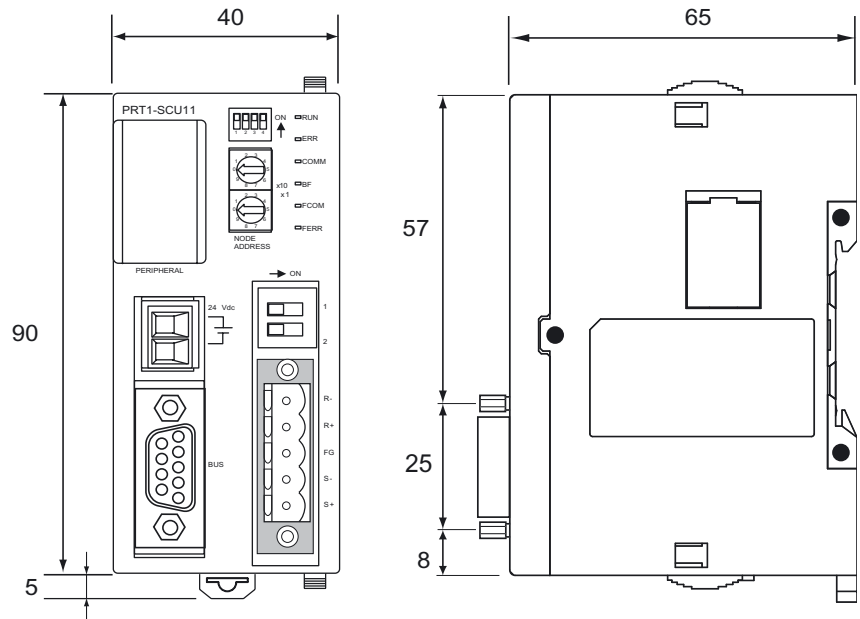

Units: mm

1-4 Basic Operating Procedure

1-4-1 Overview

The following diagram provides an overview of the installation procedures. For experienced installation engineers, this may provide sufficient information. For others, cross-references are made to various sections of this manual where more explicit information is given. When reading this manual online, the flow chart entries provide links to the sections containing detailed information.

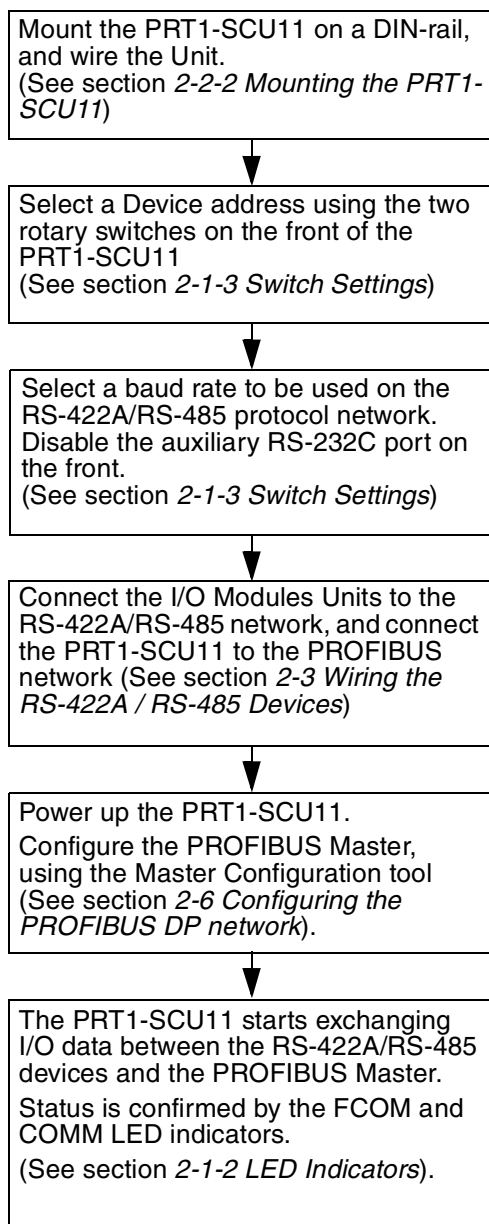

1-4-2 Procedures Prior to Starting Communications

Use the following procedure to configure the Unit using CX-Profibus:

- 1,2,3...**
1. Wire the network, to connect the PRT1-SCU11 to the RS-422A / RS-485 devices.
 2. Turn ON the PLC power supply and the power supply of the PRT1-SCU11.
 3. In CX-Profibus, create a network and define the parameters and I/O configurations for the PRT1-SCU11 settings and the allocated modules. Determine the baud rate and the bus parameter setup, see section *2-6 Configuring the PROFIBUS DP network*.
 4. Download the network configuration to the PROFIBUS DP master. After downloading the configuration, CX-Profibus will restart the PROFIBUS DP master automatically.
 5. After restarting the PRT1-SCU11 it will automatically start communication.

SECTION 2

Installation and Wiring

This section describes the PRT1-SCU11 PROFIBUS DP Gateway and identifies its controls and indicators. It contains the procedures for installing the PROFIBUS DP Gateway and setting up the PROFIBUS network.

2-1	Unit Components	18
2-1-1	Nomenclature.	18
2-1-2	LED Indicators.	18
2-1-3	Switch Settings	19
2-1-4	PROFIBUS Connector.	21
2-1-5	RS-422A / RS-485 Connector	22
2-2	Installing the PRT1-SCU11 PROFIBUS DP Gateway	23
2-2-1	Handling Precautions.	23
2-2-2	Mounting the PRT1-SCU11	23
2-2-3	Wiring the Power Terminals	23
2-3	Wiring the RS-422A / RS-485 Devices	24
2-3-1	Precautions When Wiring	24
2-3-2	2-Wire and 4-Wire Connections	24
2-3-3	Connection for E5_N Compoway-F Communications	24
2-3-4	Connection for E5ZN Compoway-F Communications	25
2-3-5	Connection for E5AR/E5ER Compoway-F Communications	26
2-3-6	Connection for R88A-MCW151-E Host Link Communications	27
2-3-7	Connection for E5AK/E5EK K-Format Communication	28
2-3-8	Connection for F7 Inverter Memobus Communication	29
2-4	Initial Setup Procedure	30
2-4-1	Selecting a Node Address	30
2-5	Setting up a PROFIBUS Network.	31
2-5-1	Network Structure	31
2-5-2	Bus Termination.	33
2-5-3	PROFIBUS Cable Connector	34
2-5-4	Shielding Precautions	34
2-6	Configuring the PROFIBUS DP network	35
2-6-1	Configuring the Slave Devices	35
2-6-2	Defining the I/O Configuration	36
2-6-3	Setting Parameters	38

2-1 Unit Components

2-1-1 Nomenclature

The illustration below shows the DIP-switches, physical layer switches, auxiliary RS-232C port (behind cover), the status LED indicators, the unit number selector switch, and a 9-pin female sub-D connector on the front side of the PRT1-SCU11. Each of these components is explained in the following sections.

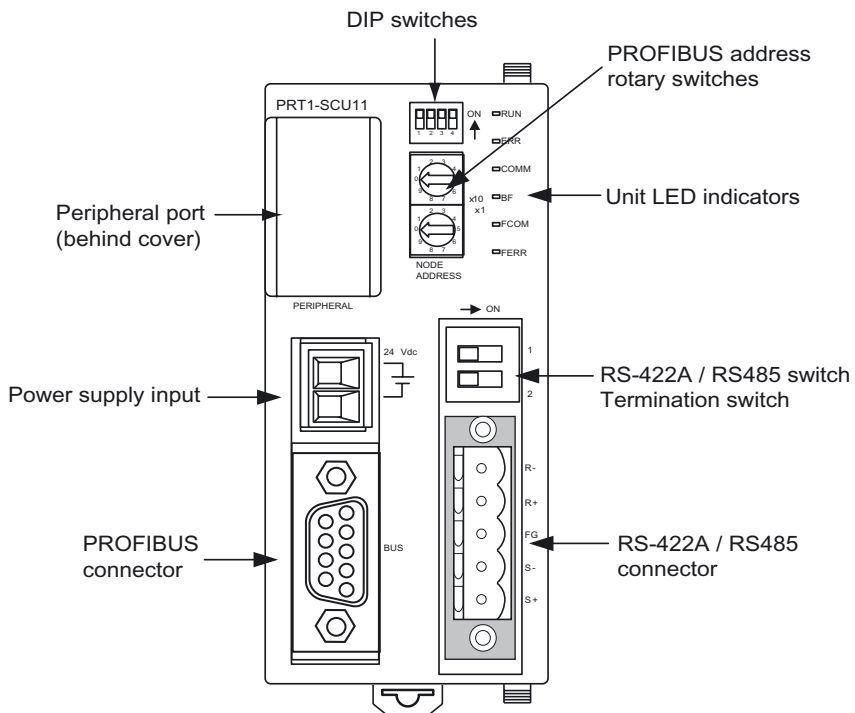

2-1-2 LED Indicators

The PRT1-SCU11 has six colored (red and green) LED's to indicate the operational mode, and status of the Unit, the status of the PROFIBUS interface and the status of the RS-422A / RS-485 interface.

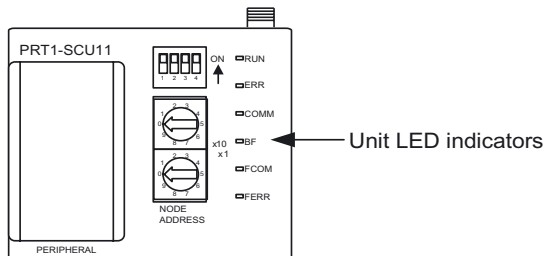

Indicator Specifications

Indicator	Color	Status	Description
RUN	Green	Not lit	<ul style="list-style-type: none"> Startup test failed, Unit not operational. Operation stopped due to a fatal error. Power is off.
		Lit	Initialization successful, Unit is in normal operation.
ERR (unit error)	Red	Not lit	The PRT1-SCU11 is in normal operation (RUN LED is lit).
		Flashing	The Unit was not able to initialize normally due to a fatal error during system startup.
		Lit	Fatal error during operation occurred.
FCOM (RS-422A / RS-485 communication)	Green	Not lit	No communication with any devices attached to the RS-422A / RS-485 network. This may be caused by: <ul style="list-style-type: none"> a communication failure (broken wire). a non initialized PROFIBUS DP interface. the PRT1-SCU11 is not able to exchange data with all configured devices.
		Flashing	Communication with the RS-422A / RS-485 network is performed through the auxiliary port. The PROFIBUS DP interface is bypassed.
		Lit	RS-422A / RS-485 communication active, no errors.
FERR (RS-422A / RS-485 communication)	Green	Not lit	No RS-422A / RS-485 network errors present. The PRT1-SCU11 is exchanging data with all configured devices.
		Lit	A failure occurred in the RS-422A / RS-485 network communication.
COMM (PROFIBUS communication)	Green	Not lit	The PRT1-SCU11 is not in Data_Exchange with the PROFIBUS DP master.
		Flashing	Auxiliary port ready, PROFIBUS DP interface is not active.
		Lit	The PRT1-SCU11 is in Data_Exchange with the PROFIBUS DP master.
BF (PROFIBUS Bus fail)	Green	Not lit	No PROFIBUS DP communication errors, Set_Prm and Chk_Cfg messages have been accepted. Data_Exchange in progress.
		Flashing	Either the Set_Prm or the Chk_Cfg message has been rejected by the PRT1-SCU11. The Unit is not in Data Exchange with the PROFIBUS DP master.
		Lit	All communication with the PROFIBUS DP master is lost. The PRT1-SCU11 is awaiting a new Set_Prm message.

2-1-3 Switch Settings

Node address

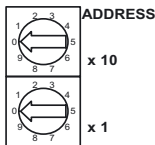

Two rotary switches on the front of the PRT1-SCU11, marked Address x10 and x1, are provided to set the PROFIBUS DP device address of the Unit. The address can be set in the range of 00 through 99. The device address on the Unit must be the same as the address used in the master's configuration.

The device address is used to identify individual slave devices on the PROFIBUS DP network. The device address must be unique for each unit. Selecting a non-unique address for a unit will prevent the PROFIBUS DP network from starting or operating correctly.

In order to set the device address, perform the following steps.

- 1,2,3... 1. Turn OFF the power supply before setting the device address.
2. Set the switch to the (new) device address. Use a small screwdriver to make the setting, taking care not to damage the rotary switch. The node address is factory-set to 0.
3. Turn ON the power again.

Note Always turn OFF the power to the Unit before changing the device address setting. The Unit only reads the address setting during the initialization following a power-up, i.e. any changes after power up will have no effect.

Baud rate setting

In order to select the baud rate used for communication over the RS-422A/RS-485 network, two DIP-switches are available. Baud rate switches are part of the DIP-switch bank of 4 switches on the front-case of the Unit. Switch 1 and 2 are used to select the baud rate to be used for communication over the RS-422A / RS-485 network. The possible combinations are summarized below.

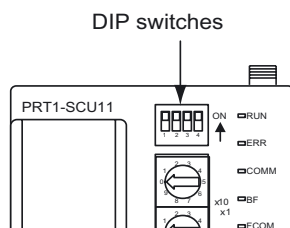

DIP-Switch 1	DIP-Switch 2	Baud rate (bits/sec.)
OFF	OFF	9600 (default)
OFF	ON	19200
ON	OFF	38400
ON	ON	Reserved for future use

Note The two DIP-switches for the baud rate are only read during power-up/restart of the PRT1-SCU11. Changing them during operation has no effect.

Communication Format Selection

DIP-Switch 3 allows the user to select the communication protocol on the RS-422A / RS-485 network, to be either Memobus or one of the other protocols.

DIP-Switch 3	Description
OFF	<p>Communication protocol on RS-422A / RS-485 is</p> <ul style="list-style-type: none"> • Compoway-F • Host Link • K-Format <p>Note Selection of the protocol is made through I/O module selection in the PROFIBUS Master configuration.</p> <p>Note The communication format used is 7 data bits, 2 stop bits, 1 even parity bit.</p>
ON	<p>Communication protocol on RS-422A / RS-485 is Memobus.</p> <p>Note The communication format used is 8 data bits, 1 stop bit, 1 even parity bit.</p>

Note The communication format selection must be set prior to power-up. Changes made during operation have no effect.

Auxiliary Port Selection

DIP-Switch 4 allows the user to enable or disable the use of the RS-232C Port, behind the cover next to the DIP-switches.

DIP-Switch 4	Description
OFF	<p>PROFIBUS to Compoway-F and Host Link is active. The RS-232C Auxiliary Port is inactive.</p> <p>Communication from PROFIBUS is rerouted to the RS-485/RS-422A communication port.</p>
ON	<p>PROFIBUS to Compoway-F and Host Link is inactive. The RS-232C Auxiliary Port is active.</p> <p>Communication from the Auxiliary Port is rerouted to the RS-485/RS-422A communication port.</p>

Note DIP-Switch 4 can be changed during operation. The selected mode is reflected through the LED Indicators.

Peripheral setting

For the physical layer settings on the RS-422A / RS-485 network port, two switches are provided on the front-case of the Unit, located close to the RS-422A / RS-485 network connector.

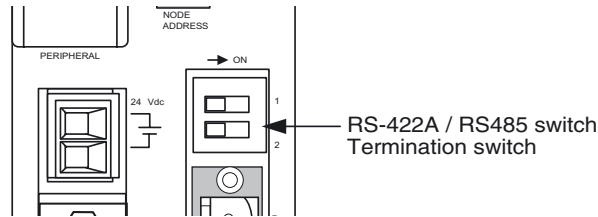

Switch 1 defines whether to use RS-422A or RS-485 as the physical layer on the RS-422A / RS-485 network.

Switch 1	Description
OFF	RS-422A
ON	RS-485

Switch 2 enables or disables the termination resistor on the RS-422A / RS-485 receiver channel.

Switch 2	Description
OFF	220 Ohm Termination resistor disabled.
ON	220 Ohm Termination resistor enabled.

The two switches are independent of the selected protocol. They can be changed during operation and take effect immediately.

- Note**
1. It is recommended to switch the power off before changing switches.
 2. If the wrong combination is selected for this PRT1-SCU11 (e.g. Host Link and RS-485 or Compoway-F and RS-422A), the communication between the PRT1-SCU11 and the connected devices may not work. The Unit has no direct way of detecting this, apart from a possible time-out.

2-1-4 PROFIBUS Connector

The PROFIBUS connector on the front of the Unit is a 9-pin female sub-D connector, as recommended by the PROFIBUS standard EN50170.

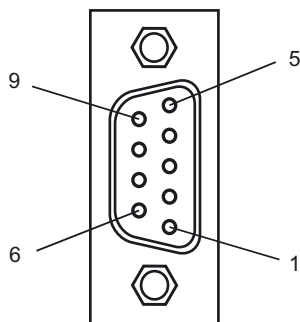

Pin No.	Signal	Description
1	Shield	Shield/protective ground
2	--	
3	B-line	Receive/Transmit data - plus (B wire)
4	RTS	Control signal for repeaters (direction control) (TTL)
5	DGND	Data ground (reference potential for VP)
6	VP	Supply voltage of the terminator resistance (5 Vdc)
7	--	
8	A-line	Receive/Transmit data - minus (A wire)
9	-	-

The signal RTS (TTL signal) is for the direction control of repeaters, which do not have a self-controlling capability.

The signals DGND and VP are used to power the bus terminator located in the cable connector.

- Note**
1. The orientation of the sub-D connector allows the use of PROFIBUS connectors with a 90° angle cable outlet, e.g ERNI, Delconec and Phoenix.
 2. The 9-pin sub-D connector uses #4/40 UNC thread for mechanical fixation of the cable connector. Make sure that if non-standard PROFIBUS connectors are used, the same thread is used on the cable connector.
 3. PROFIBUS DP Baud rate setting is accomplished through automatic detection, all the defined PROFIBUS DP baud rate values are supported.

2-1-5 RS-422A / RS-485 Connector

The RS-422A / RS-485 port is a dedicated RS-422A / RS-485 compliant interface, which is galvanically isolated. The PRT1-SCU11 has a switch on the front case, allowing the user to select either the RS-422A or the RS-485 physical layer. The Unit also provides a switch to turn a 220 Ohm termination resistor ON or OFF. The termination resistor is placed inside the Unit and between the two receiver lines of either RS-422A or RS-485.

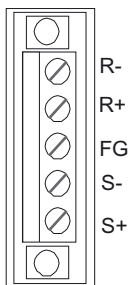

Pin No.	Description	
	RS-422A (Switch1 OFF)	RS-485 (Switch 1 ON)
R-	RD- Receiver line	A line Transmit/Receive line
R+	RD+ Receiver line	B line Transmit/Receive line
FG	Frame Ground	Frame Ground
S-	SD- Transmission line	A line Transmit/Receive line
S+	SD+ Transmission line	B line Transmit/Receive line

- Note** In case Switch 1 is set to ON and RS-485 is selected, the A and B lines are doubled on the S-/S+ connector pins, i.e. the signal on R- is the same signal as on S- and the signal on R+ is the same signal as on S+.

Address setting

The communication through the RS-422A / RS-485 interface does not require a separate address setting feature. All connected devices must have addresses selected in the range of 1 through 15. The address set on the device must match the slot number of the selected PROFIBUS I/O-module. Free Communication Blocks carry their own address as part of the message itself.

The default communication format used on the RS-422A / RS-485 interface depends on whether Memobus or one of the other protocols will be used, i.e. it depends on the setting of DIP-switch 3. The table below lists the default communication settings used.

Format	Memobus (DIP-Switch 3 ON)	Compoway-F / Host Link / K-Format (DIP-switch 3 OFF)
Data length	8 bits	7 bits
Stop bit length	1 bits	2 bits
Error detection	1 bit, even parity	1 bit, even parity

2-2 Installing the PRT1-SCU11 PROFIBUS DP Gateway

2-2-1 Handling Precautions

When installing the PROFIBUS DP Gateway, observe the following handling precautions

- Always turn OFF the power supply to the Unit before mounting or dismounting the Unit or connecting or disconnecting cables.
- Provide separate conduits or ducts for the I/O lines to prevent noise from high-tension lines or power lines.
- Prevent foreign matters to enter the Unit when wiring. Failure to do so, may result in malfunction if foreign matter enters the Unit.

2-2-2 Mounting the PRT1-SCU11

The PRT1-SCU11 can be mounted directly on a DIN-rail.

Mounting Procedure

Mount the PRT1-SCU11 to the DIN-rail using the following procedure.

 **Caution** Always turn OFF the power supply to the Unit before mounting or dismounting the Unit or connecting or disconnecting cables.

- 1,2,3...**
1. Pull the hook down on the bottom.
 2. Latch the top hook onto the track
 3. Push the Unit until the hook locks onto the track.
 4. Push the hook back up to lock the Unit in place.

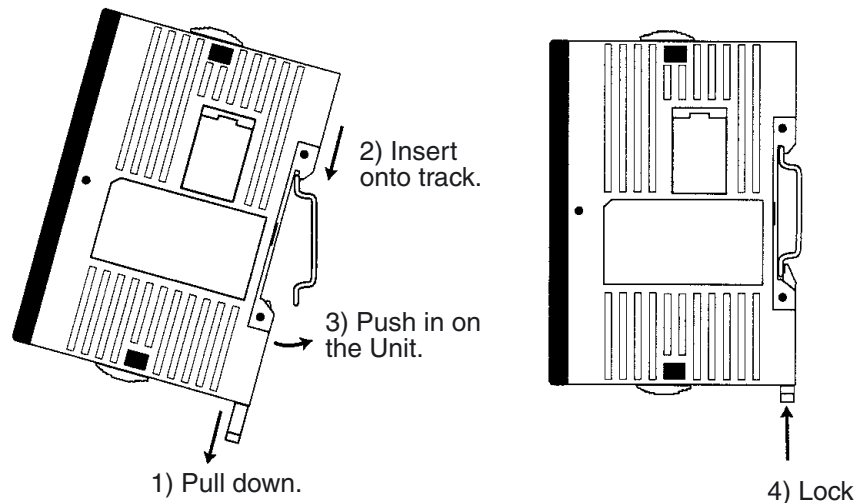

2-2-3 Wiring the Power Terminals

- Supply power to the Unit using the 2 pin power connector provided with the Unit.
- When wiring the power, observe the required polarity. Failure to do so can damage the Unit.
- Use a Phillips screw driver to tighten the connector screw, using a torque value between 0.25 and 0.3 N-m.

2-3 Wiring the RS-422A / RS-485 Devices

2-3-1 Precautions When Wiring

- Always switch off the power to the Unit and to the RS-422A / RS-485 devices, before wiring.
- Make sure that no foreign objects enter the Unit when wiring. Failure to do so, may damage the Unit when power is applied.
- Use a Phillips screw driver to secure the network connector to the Unit after setting up the RS-422A / RS-485 network. Tighten the screws to a torque of 0.25 to 0.3 Nm.

2-3-2 2-Wire and 4-Wire Connections

The transmission circuits for 2-wire and 4-wire connections are different, as shown in the following diagram.

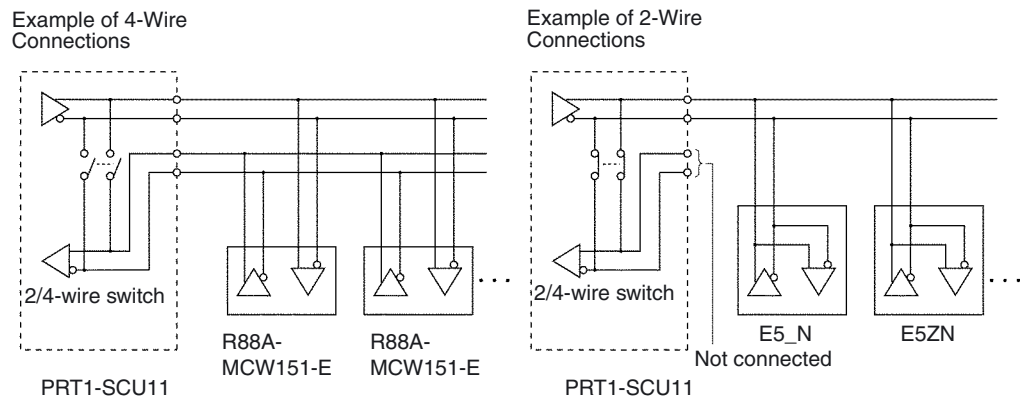

- Note**
1. Use a 2-wire transmission circuit to connect E5_N, E5ZN and E5_R Temperature Controllers to the PRT1-SCU11. Use a 4-wire transmission circuit to connect the R88A-MCW151-E Motion Control option Board to the PRT1-SCU11. Use the same transmission circuit (2-wire or 4-wire) for all nodes.
 2. Do not use 4-wire connections when the 2/4-wire switch on the PRT1-SCU11 is set to 2-wire.
 3. Do not intermix Temperature Controllers, R88A-MCW151-E devices and F7-Inverter devices on one and the same transmission circuit.
 4. In case the PRT1-SCU11 is on one of the ends of the transmission network, switch on the Termination Resistor - by setting Switch 2 to ON.

2-3-3 Connection for E5_N Compoway-F Communications

The E5AN / E5CN / E5EN / E5GN Temperature Controllers all use Compoway-F communications over 2-wire RS-485.

- The RS-485 connection can be either one-to-one or one-to-N. Up to 15 E5_N units can be connected in a one-to-N system.
- The total cable length is 500 m max.
- Use a shielded twisted-pair cable with wires of a thickness of AWG24 (0.205 mm²) to AWG14 (2.081 mm²)

The figure below shows the connection between one PRT1-SCU11 and 1 to 15 E5_N Temperature Controller units. Refer to the E5AN / E5CN / E5EN and E5GN User Manuals for more information on Wiring.

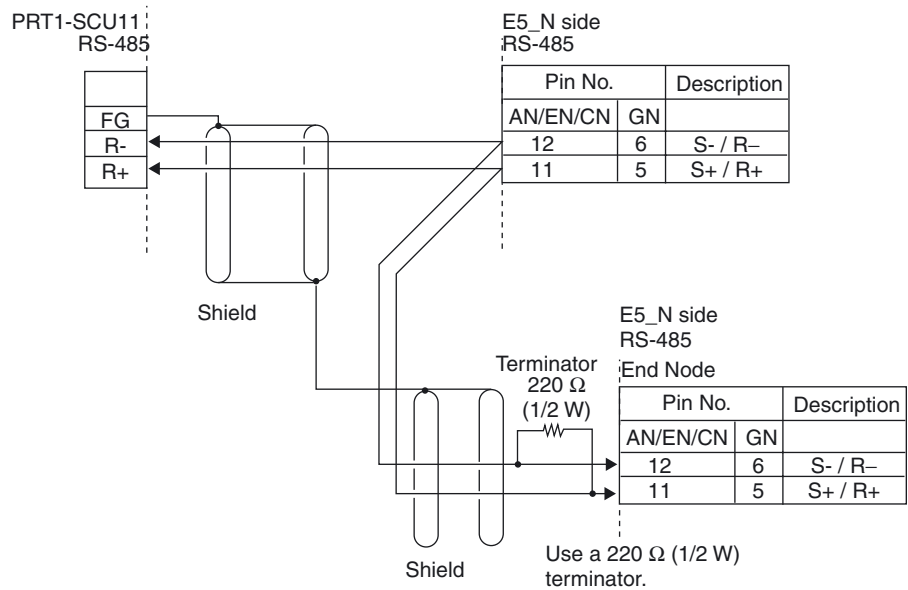

This way of communication also allows the use of other stand-alone Compoway-F instruments, for example a K3GN Digital Panel Meter.

Note The E5AN / E5CN / E5EN and E5GN support baud rates of 9.6 and 19.2 kbits/sec. Ensure that the PRT1-SCU11 baud rate setting (DIP-switch 1 and 2) is set to the correct setting.

2-3-4 Connection for E5ZN Compoway-F Communications

The E5ZN Temperature Controllers use Compoway-F communications over 2-wire RS-485. Multiple E5ZN units can be connected together, using one RS-485 Terminal. The RS-485 connection is extended through the E5ZN sockets. However, these units all have unique RS-485 addresses.

The RS-485 connection can be either one-to-one or one-to-N. Up to 15 E5ZN units can be connected in a one-to-N system.

The figure below shows the connection between one PRT1-SCU11 and 1 to 15 E5ZN Temperature Controller units. Refer to the E5ZN User Manuals for more information on Wiring.

Note The E5ZN supports baud rates of 9.6, 19.2 and 38.4 kbits/sec. Ensure that the PRT1-SCU11 baud rate setting (DIP-switch 1 and 2) is set to the correct setting.

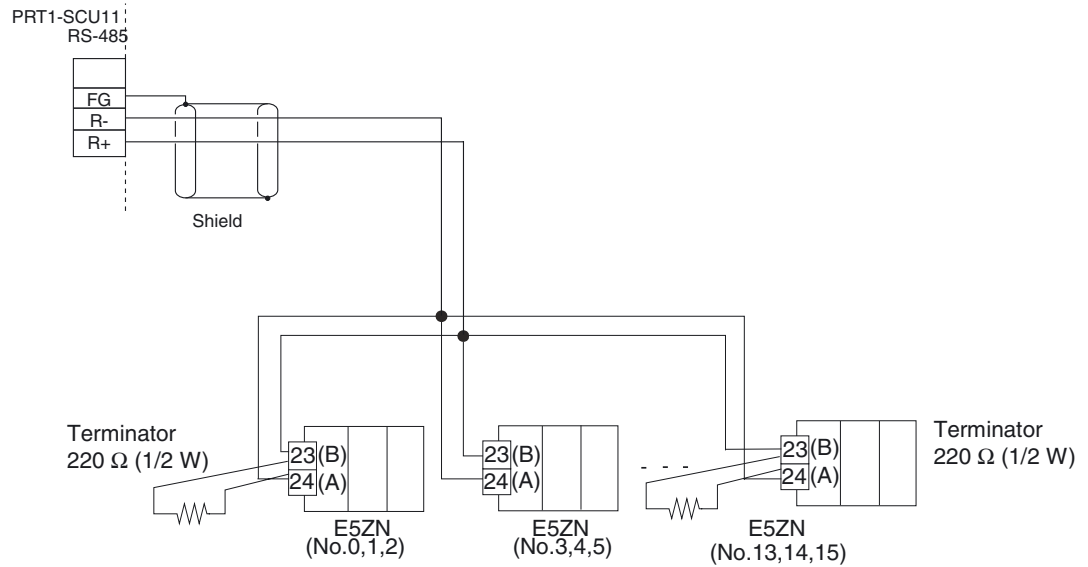

2-3-5 Connection for E5AR/E5ER Compoway-F Communications

The E5AR/E5ER Temperature Controllers all use Compoway-F communications over 2-wire RS-485.

- The RS-485 connection can be either one-to-one or one-to-N. Up to 15 Temperature Controller units can be connected in a one-to-N system.
- The total cable length is 500 m max.

The figure below shows the connection between one PRT1-SCU11 and 1 to 15 E5AR/E5ER Temperature Controller Units. Refer to the E5AR/E5ER User Manuals for more information on Wiring.

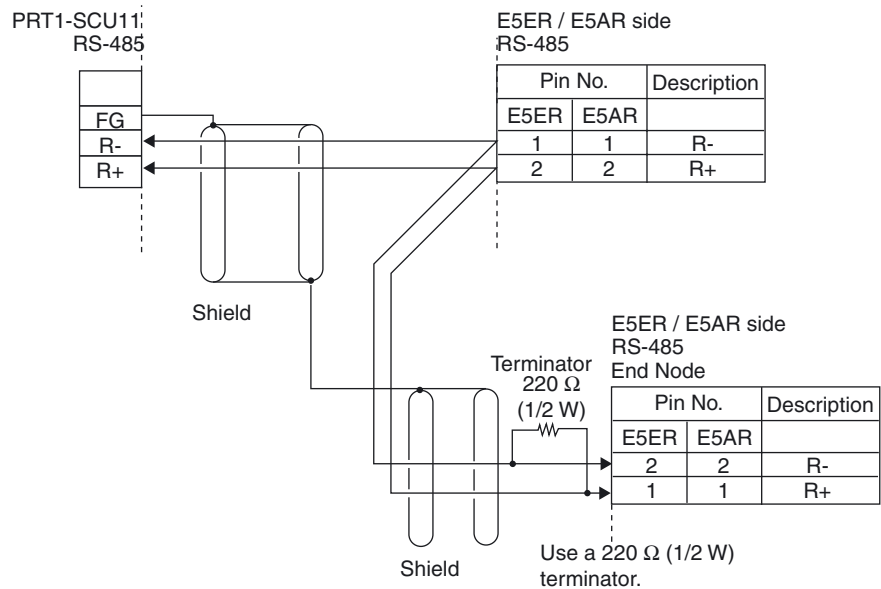

Note The E5AR/E5ER supports baud rates of 9.6, 19.2 and 38.4 kbits/sec. Ensure that the PRT1-SCU11 baud rate setting (DIP-switch 1 and 2) is set to the correct setting.

2-3-6 Connection for R88A-MCW151-E Host Link Communications

The R88A-MCW151-E uses Host link communications over 4-wire RS-422A. The figure below shows the connection between one PRT1-SCU11 and 1 to 15 R88A-MCW151-E units.

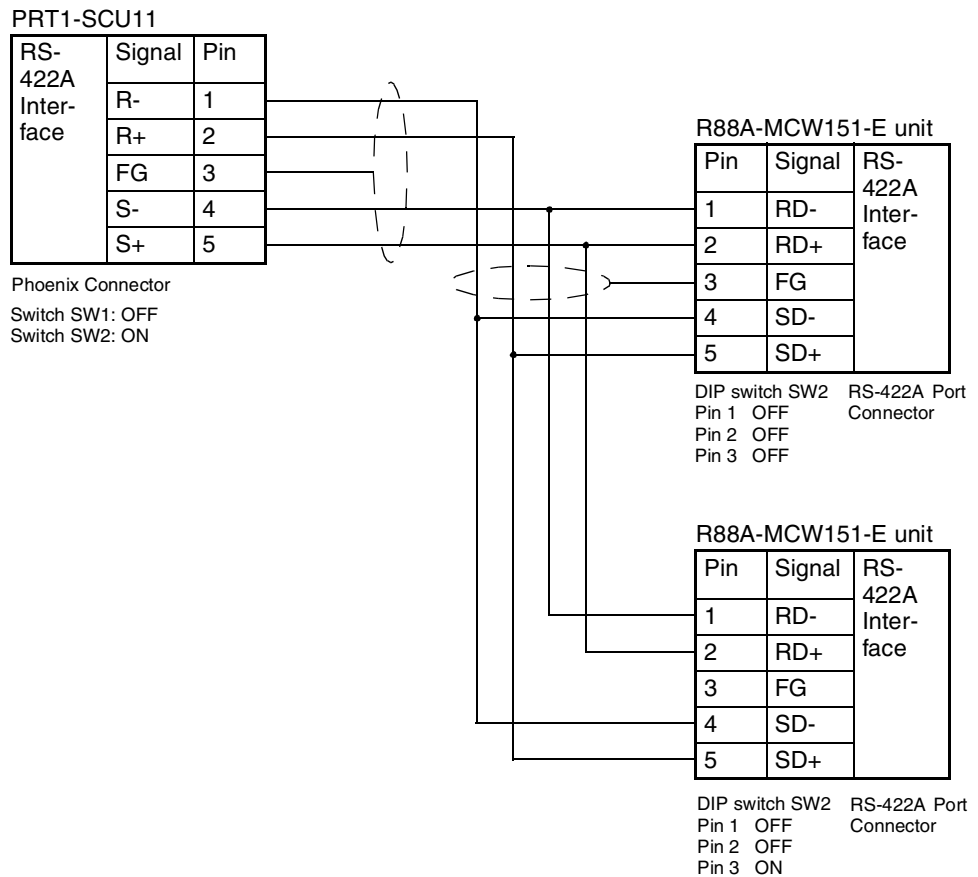

- Note**
1. If the PRT1-SCU11 is connected on one end of the transmission circuit, the termination resistor must be enabled on the Unit, by setting Switch 2 to ON.
 2. The R88A-MCW151-E connected at one end of the transmission circuit, must also have its termination resistor enabled, by setting Pin 3 of DIP-switch SW2 to ON.
 3. The R88A-MCW151-E supports baud rates of 9.6, 19.2 and 38.4 kbits/sec. Ensure that the PRT1-SCU11 baud rate setting (DIP-switch 1 and 2) is set to the correct setting.

2-3-7 Connection for E5AK/E5EK K-Format Communication

The E5AK/E5EK Intelligent Digital Controllers use the K-Format communications over either 4-wire RS-422A or 2-wire RS-485. Both are supported, through dedicated communication option units. Refer to the E5AK/E5EK User Manuals for more information on these dedicated communication units.

RS-422A Connection to E5AK/E5EK

The RS-422A connection can be either one-to-one or one-to-N. Up to 15 E5AK/E5EK units can be connected in a one-to-N system.

The figure below shows the connection between one PRT1-SCU11 and 1 to 15 E5AK/E5EK Intelligent Digital Controller units. The table below shows the pin numbers used on the E5AK and E5EK units for connection of communication signals. Refer to the E5AK/E5EK User Manuals for more information on Wiring.

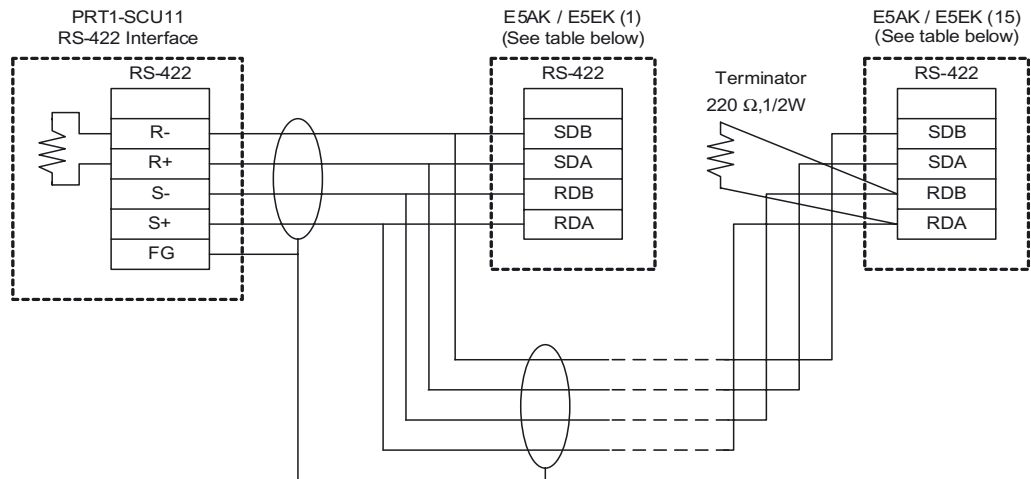

RS-422A Signal	E5AK Pin number	E5EK Pin number
SDB (Transmission line)	31	21
SDA (Transmission line)	32	22
RDB (Receiver line)	20	20
RDA (Receiver line)	19	19

RS-485 Connection to E5AK/E5EK

The E5AK/E5EK Intelligent Digital Controllers can also communicate over RS-485, using the dedicated communication option for RS-485. Refer to the E5AK/E5EK User Manuals for more information on the RS-485 dedicated communication unit.

The RS-485 connection can be either one-to-one or one-to-N. Up to 15 E5AK/E5EK units can be connected in a one-to-N system.

The figure below shows the connection between one PRT1-SCU11 and 1 to 15 E5AK/E5EK Intelligent Digital Controller units. Refer to the E5AK/E5EK User Manuals for more information on Wiring

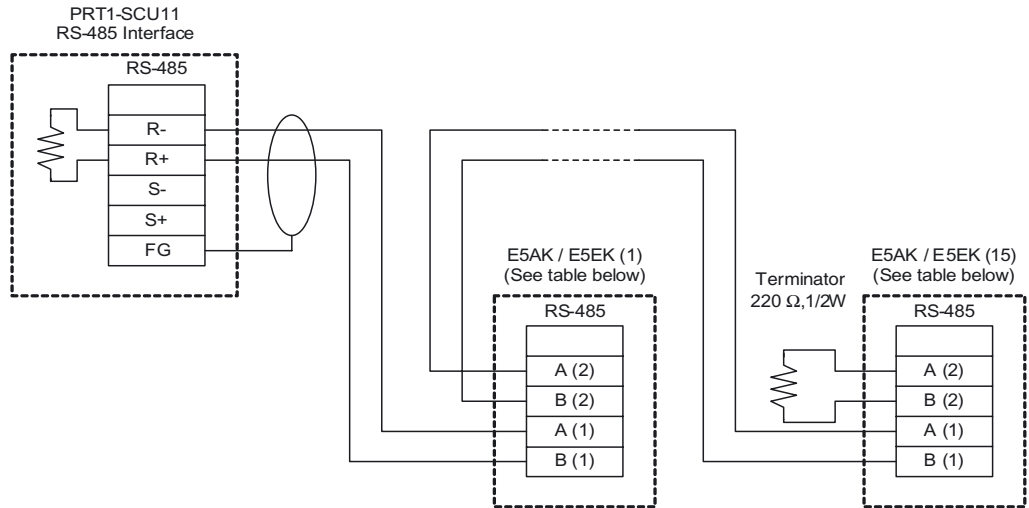

RS-485 Signal	E5AK Pin number	E5EK Pin number
A (2)	32	22
B (2)	31	21
A (1)	19	19
B (1)	20	20

Note The E5AK/E5EK supports baud rates of 9.6, and 19.2 kbits/sec. Ensure that the PRT1-SCU11 baud rate setting (DIP-switch 1 and 2) is set correctly.

2-3-8 Connection for F7 Inverter Memobus Communication

The F7 Inverter use the Memobus communications over either 4-wire RS-422A or 2-wire RS-485.

RS-422A Connection to F7 Inverter

The RS-422A connection can be either one-to-one or one-to-N. Up to 15 F7 Inverter units can be connected in a one-to-N system.

The figure below shows the connection between one PRT1-SCU11 and 1 to 15 F7 Inverter units. Refer to the F7 Inverter User Manual for more information on Wiring.

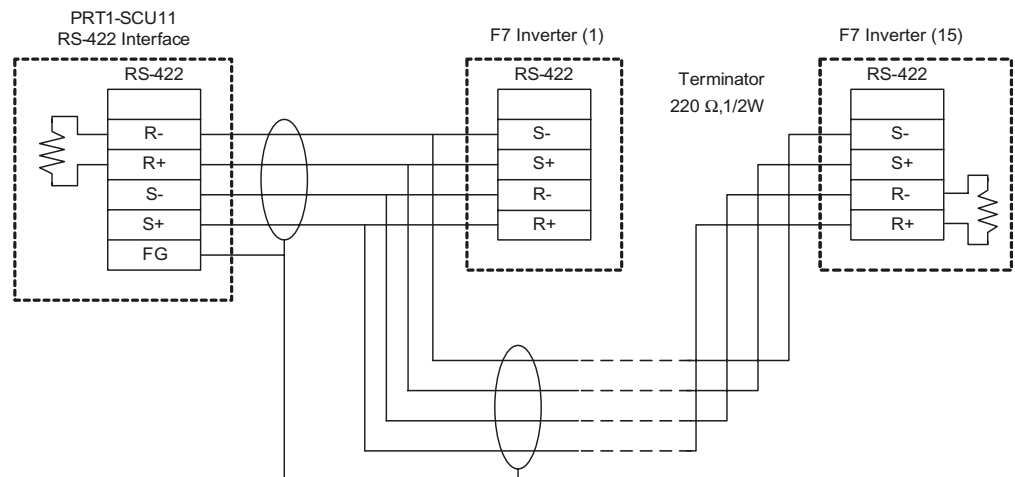

RS-485 Connection to F7 Inverter

The F7 Inverter can also communicate over RS-485. The RS-485 connection can be either one-to-one or one-to-N. Up to 15 F7 Inverter units can be connected in a one-to-N system.

The figure below shows the connection between one PRT1-SCU11 and 1 to 15 F7 Inverter units. Refer to the F7 Inverter User Manuals for more information on Wiring.

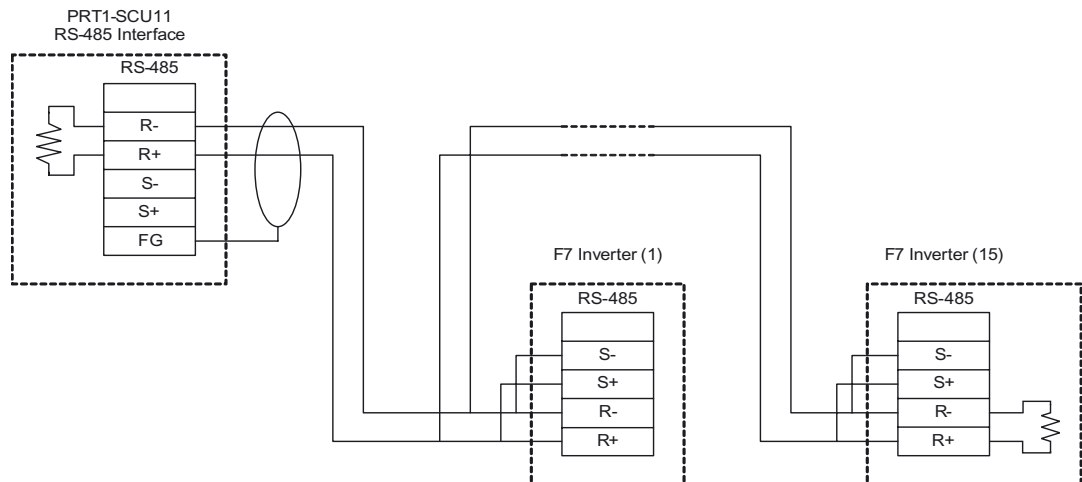

2-4 Initial Setup Procedure

After mounting the PRT1-SCU11, the following Initial Setup Procedure must be applied to allow the Unit to start up properly and to be configured for operation.

- A unique PROFIBUS node address must be selected, before the unit's power supply is turned on, see section 2-4-1 *Selecting a Node Address*.
- Select the required baud rate to be used on the RS-422A / RS-485 network, using DIP-switches 1 and 2. Select the protocol to be used, i.e. Memobus or one of the other protocols, using DIP-switch 3. Disable the Auxiliary port, using DIP-switch 4.
- Select the required physical layer, either RS-422A or RS-485, using switch number 1, directly over the RS-422A / RS-485 connector.
- Setup the PROFIBUS network, see section 2-5 *Setting up a PROFIBUS Network*, configure the PROFIBUS Master unit using the master configuration tool on the Personal Computer, and download the configuration to the master unit.
- Refer to the manuals of the connected devices, on how to set up the devices.

2-4-1 Selecting a Node Address

- 1,2,3...
1. Make sure that the power supply is turned OFF before setting the node address.
 2. Set the switch to the desired node address, using a small screwdriver, and taking care not to damage the rotary switch. The default node address is 0. Make sure that the node address is unique on the PROFIBUS DP network, i.e. there must be no other unit with the same node address.
 3. Turn ON the power supply of the Unit.

2-5 Setting up a PROFIBUS Network

2-5-1 Network Structure

Communication Medium The PROFIBUS standard defines the use of EIA RS-485 as the main communication transport medium. The PRT1-SCU11 is designed to interface directly to this type of medium. This section will discuss the setup of networks based on this medium.

Note The other communication medium specified for PROFIBUS is optical fibre. The PRT1-SCU11 does not provide a direct interface to this type of medium. However, by using third party couplers an interface between EIA RS-485 and optical fibre networks can be made.

Linear Bus Topology PROFIBUS DP defines the use of the Linear Bus Network Topology. The Bus must be terminated at both ends, and must not contain network branches. The total cable length of the bus depends on the cable and the selected baud rate. Also, RS-485 specifies a maximum of up to 32 devices - master and slave devices - per line segment. If more than 32 devices are to be connected, or if the total length of the segment must be extended beyond its maximum, repeaters must be used to link the separate segments.

Note Repeaters are devices which connect two segments. They do not have a device address of their own, but they do count in the total number of devices in a segment.

Repeaters A maximum of up to three repeaters between two devices in a network can be used, i.e. a network can consist of up to 4 segments. The maximum number of PROFIBUS devices in such a network is then 122. The figure below shows an example of a two-segment network.

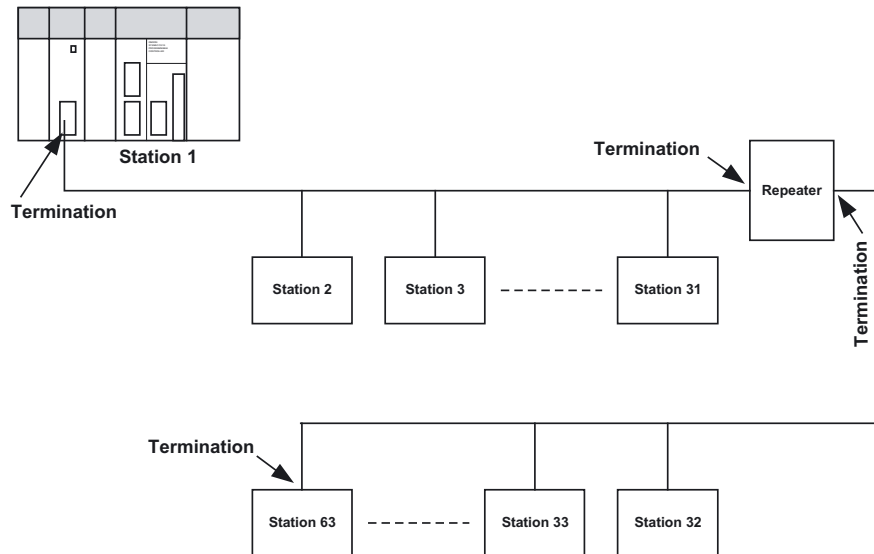

Tree Topology The use of repeaters allows the extension of three or more Linear Bus segments into a Tree topology. In a tree topology more than three repeaters are allowed, provided that there are no more than three repeaters between any

two devices in the network. The following figure presents an example of a network with more than three segments and repeaters.

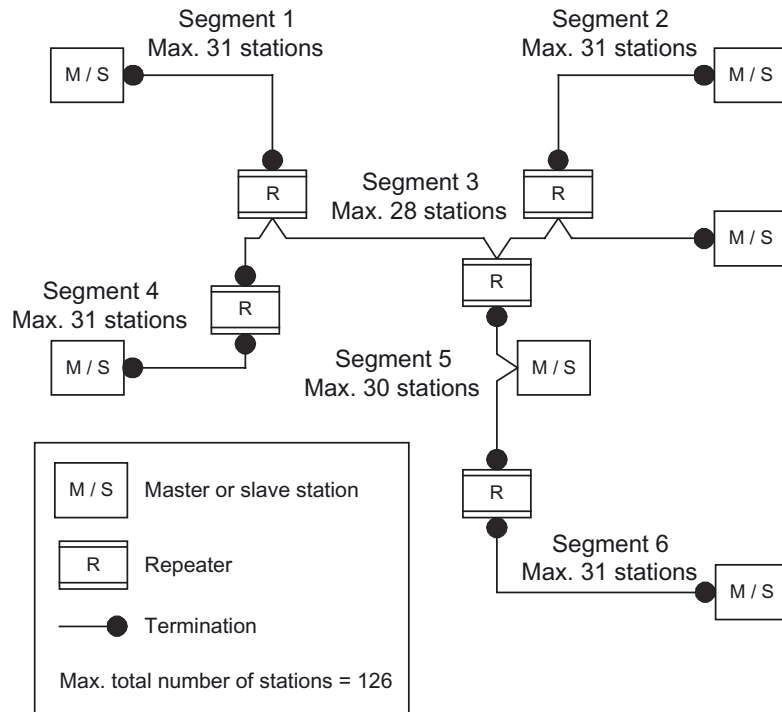

Cable Type

The PROFIBUS standard EN 50170 specifies Type A shielded, twisted-pair cable as the recommended cable type for use in an RS-485 based PROFIBUS network. This cable type has the following characteristics:

Characteristic	Value
Impedance	135 - 165 ohms
Capacitance per unit length	< 30 pF/m
Loop resistance	110 ohms/km
Core diameter	0.64 mm
Core cross section	0.34 mm ²

Note The PROFIBUS standard EN 50170 also specifies a Type B cable with slightly different cable characteristics. This Type B cable is no longer recommended for use.

Maximum PROFIBUS Cable Length

The transmission speed defines the maximum advised cable distance or cable segment in metres before the use of a repeater is recommended. The cable lengths specified in the following table are based on PROFIBUS type A cable.

Baud rate (kbit/s)	Distance/segment (m)	Baud rate (kbit/s)	Distance/segment (m)
9.6	1200	500	400
19.2	1200	1500	200
45.45	1200	3000	100
93.75	1200	6000	100
187.5	1000	12000	100

Note If the network must be extended beyond the range of the advised cable length, the use of a fibre optic segment to cross the larger distance should be considered.

Stub Lines

Passive Stub lines (branches from the main line) should be avoided for data transmission speeds of more than 500 kbit/s. Except at end devices with termination, it is recommended to always use plug connectors that permit two data cables to be connected directly to the plug. This method allows the bus connector to be plugged and unplugged at all times without interrupting data communication between other devices.

2-5-2 Bus Termination

Termination Resistors

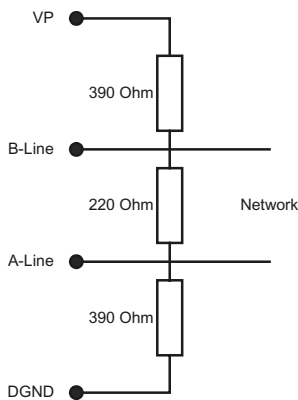

In order to minimize cable reflections and ensure a defined signal level on the data lines, the data transfer cable must be terminated at both ends with a terminating resistor combination. The bus termination diagram is shown on the left.

The bus terminator connects the two data lines via a 220 ohm resistor which, in turn, is connected to VP 5Vdc and DGND via two 390 ohm resistors. Powering the terminator resistor via VP 5V and DGND ensures a defined idle state potential on the data lines.

To ensure the correct functioning up to the highest baud rate, the bus cable must be terminated at both its ends.

A missing bus termination can cause errors during data transfer. Problems can also arise if too many bus terminators are fitted, since each bus terminator represents an electrical load and reduces the signal levels and thus the signal-to-noise ratio. Too many or missing bus terminators can also cause intermittent data transfer errors, particularly if the bus segment is operated close to the specified limits for maximum numbers of devices, maximum bus segment length and maximum data transfer rate.

Inductors

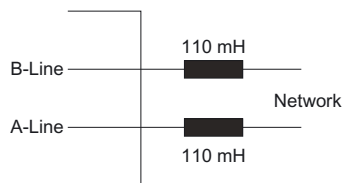

In addition to the bus termination, additional precautions must be taken to ensure proper operation at high baud rates, i.e. baud rates of 500 kbit/s and higher. Due to the capacitive load of the device and the resulting cable reflections, bus connectors must be provided with built-in series inductors, of 110 mH each, as shown in the figure on the left.

Installing the inductors applies to all devices on the network, and not only to the devices at both ends of the bus cable.

2-5-3 PROFIBUS Cable Connector

Bus Cable Connector

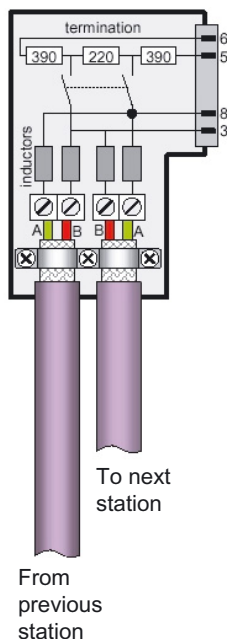

The plug connector to be used on the PRT1-SCU11 is a 9-pin male sub-D type, preferably encased in metal and having a facility to connect the shield of the cable to the case or to pin 1. The cable should be connected to the receive / transmit lines, pin 3 (B-line) and pin 8 (A-line).

The use of special PROFIBUS DP cable connectors, which are available from several manufacturers, is highly recommended. Various models are widely available, with or without the bus termination and inductors built-in. If provided in the connector, the Bus termination can often be enabled or disabled through a switch on the connector.

The special PROFIBUS DP cable connectors often provide a convenient way of connecting the cables. The figure on the left, provides an example of such a bus cable connector.

A standard 9-pin sub-D plug can only be used if the PRT1-SCU11 is not at the start or the end of a bus segment, or on a stub line at a baud rate of 500 kbit/s or less.

The two PROFIBUS data lines are designated A and B. There are no regulations on which cable core color should be connected to which of the two data terminals on each PROFIBUS device; the sole requirement is to ensure that the same core color is connected to the same terminal (A or B) for all devices throughout the entire system (across all devices and bus segments). The PROFIBUS Organization recommends the following rule for data line color codes: PROFIBUS cables in general will use the colors red and green for the data lines, with the following assignment:

Data cable wire A - green

Data cable wire B - red

This rule applies to both the incoming and the outgoing data lines.

2-5-4 Shielding Precautions

Cable Shield Connection

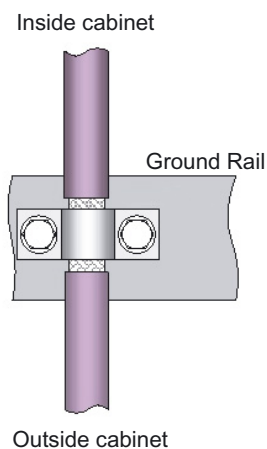

To ensure electro-magnetic compatibility (EMC), the shield of the cable should be connected to the metal case of the plug connector.

When entering the control cabinet in which the PRT1-SCU11 Unit is installed, the bus cable shield should be brought into physical contact with a grounding rail using a grounding clamp or similar device. The cable shield should continue in the cabinet right up to the PROFIBUS device.

Ensure that the Unit and the control cabinet in which it is mounted have the same ground potential by providing a large-area metallic contact to ground, e.g. galvanized steel to ensure a good electrical connection. Grounding rails should not be attached to painted surfaces.

For further information regarding PROFIBUS network installation, please refer to "Installation Guideline for PROFIBUS DP/FMS" (PNO Order No. 2.112), which is available at every regional PROFIBUS Organization. The information covers:

- Commissioning of PROFIBUS equipment.
- Testing the PROFIBUS cable and bus connectors.
- Determining loop resistance.
- Testing for correct bus termination.
- Determining the segment length and cable route.
- Other test methods.
- Example of an equipment report in the PROFIBUS guideline.

2-6 Configuring the PROFIBUS DP network

Defining the Configuration After making the physical connections of the network, the PROFIBUS Master unit has to be configured using the PROFIBUS Master's configuration tool. OMRON provides a Personal Computer based configuration program, called CX-Profibus (only required for OMRON masters), as well as the required DTM's for this purpose. It must be used to:

- Install new GSD-file
- Define the master(s).
- Assign slaves to their respective master(s).
- Assign slaves to groups for broadcast/multicast messages.
- Enter bus parameters, e.g. baud rate, target rotation time etc.
- Enable / Disable watchdog.
- Adjust watchdog settings

Refer to CS/CJ Series PROFIBUS DP Master Units Operation Manual (W409-E2-□) for more information on CX-Profibus.

Downloading the Configuration

The configuration must be downloaded to the Master unit after configuring it at the Personal Computer. This can be accomplished by either connecting the serial COM port of the Personal Computer to the CS1/CJ1 PLC with a serial interface cable, or use an Ethernet connection between the Personal Computer and the CS1/CJ1 PLC via an Ethernet unit.

2-6-1 Configuring the Slave Devices

After adding each of the slave DTM's to the network, configurations have to be selected for each of them. Setting up a configuration involves

- Selecting the proper I/O modules
I/O Modules represent either a fixed number of setpoint and process parameters for each connected RS-422A / RS-485 device or a fixed size I/O slot which can be used to send user defined protocol data. One type of I/O slot needs to be selected for each connected RS-422A / RS-485 device.
- Setting up the device parameters
Depending on the I/O module, device settings can be made, which will be transferred to the RS-422A / RS-485 device through the PRT1-SCU11. The PRT1-SCU11 itself will validate the settings and reject the data in case of faulty parameters.
- Selecting the group assignment, which defines the group of slave devices each slave belongs to and to allow sending Global-Control commands to this particular group.

All these settings will be downloaded to the Master unit, which will send the data to the individual slave devices over the PROFIBUS network.

Note The available I/O Modules are discussed in *SECTION 3 Operation*.

2-6-2 Defining the I/O Configuration

Opening the DTM Configuration User Interface

In order to define the I/O configuration, the DTM Configuration User Interface must be opened. The next example uses CX-Profibus to define, edit and download an I/O configuration.

The figure below, shows the DTM User Interface for the PRT1-SCU11 PROFIBUS DP slave device. The DTM Configuration User Interface displays two lists.

- The Available Modules list, which contains the I/O modules the user can select.
- The Configured Modules list, which contains all the I/O modules selected by the user.

Adding/Inserting I/O Modules

To select the I/O modules, perform one of the following procedures.

- Select the I/O module that needs to be added in the Available Modules list, and double-click it with the left mouse button. If more than one module must be added, repeat this step for the other modules.
- Select the I/O module that needs to be added in the Available Modules list, and press either the **Insert** or **Append** button.

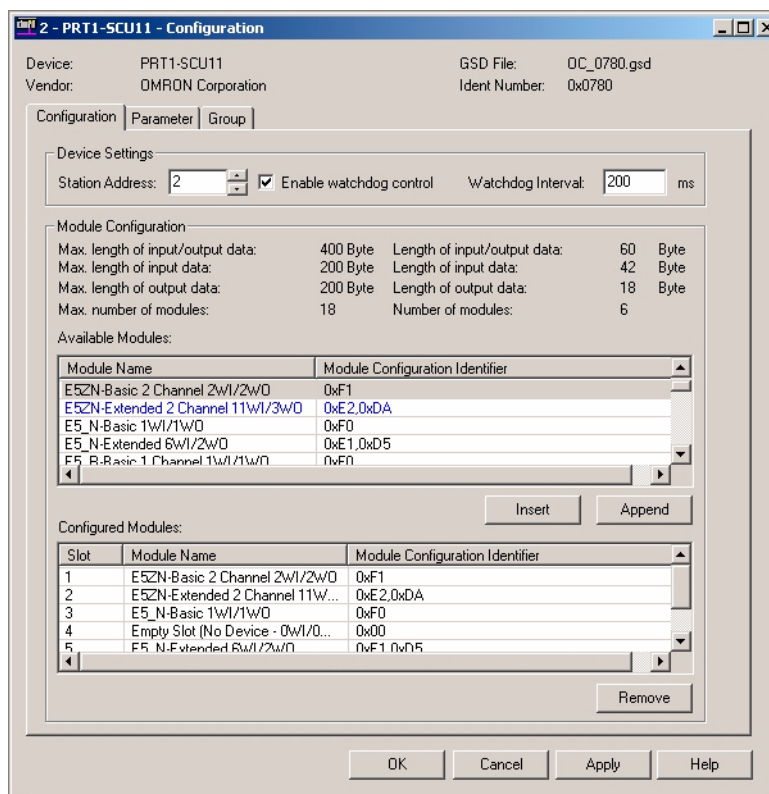

- Note**
1. When pressing the **Insert** button, the selected I/O module will be inserted above the selected module in the Configured Modules list.
 2. The selected I/O modules are sent to the slave device, in the same sequence as selected in the user interface. The sequence determines the target Temperature Controller / R88A-MCW151-E for the I/O data. For example, the I/O data of the first selected Fixed Communication Block will be sent to the first temperature Controller
 3. A mandatory I/O module sequence is sometimes indicated in the GSD file, by using non-PROFIBUS standard GSD file keywords (i.e. only interpreted

by a specific configurator). The Generic Slave DTM does not check such keywords. In this case, refer to the manual of the specific device for details.

4. Also in this window are the maximum values, which can be set, and the totals of I/O data that actually have been set. If - while selecting I/O modules - one of the maximum values is exceeded, a warning message will be displayed.

Removing I/O Modules

To remove I/O modules from the Configured Modules list, perform one of the following procedures.

- Select the I/O module that needs to be removed from the Configured Modules list, and double-click it with the left mouse button. If more than one module must be added, repeat this step for the other modules.
- Select the I/O module that needs to be removed from the Configured Modules list, and press the **Remove** button.

Example

For the PRT1-SCU11, the I/O modules for two E5ZN devices, and two E5_N devices have been selected, see figure above. The E5ZN devices have Compoway-F addresses 1 and 2, the E5_N devices have Compoway-F addresses 3 and 5. Address 4 is not used in this example.

Watchdog Settings

Apart from the I/O module selection, the Configuration tab also contains the settings for two other parameters.

1. Enable Watchdog Control

This parameter will enable/disable the monitoring of the Master-Slave communication in the slave device. If enabled, the slave will stop I/O data exchange with the Master, if the Master has not sent any request message to the slave, within the configured Watchdog time. Furthermore, the slave will

- switch its outputs to a known state.
- signal its change of state in a diagnostics message, the next time the Master addresses the slave.
- request re-parameterization from the Master, before resuming I/O data exchange.

If disabled, the slave will remain in data exchange, even if the Master is not communicating, thus maintaining its outputs in the latest known state, based on the last I/O data exchange message.

2. Watchdog Interval

This value is the watchdog time-out related to the Master-Slave communication time out.

Note Enabling the Watchdog Control is highly recommended for safe operation of the network.

 **Caution** In the current version of CX-Profibus, the watchdog value for each of the slave devices is overruled by the value determined by the Master DTM. Therefore, changing the value in the Generic Slave DTM has no effect.

2-6-3 Setting Parameters

The parameters are sent by the Master unit to the slave device prior to establishing I/O data exchange. The slave device will reject incorrect parameters and not establish I/O data exchange, unless the parameters are changed.

In general there will be two types of parameters.

- Common Parameters

The PRT1-SCU11 defines one Common parameter, which applies to the unit itself. This parameter - Fail Safe support - defines whether or not the unit will accept empty output messages or messages containing all zeros in case the PROFIBUS DP Master switches to Clear mode. Clear mode is often the indication of a failure on the network.

- Module Parameters

Modular Parameters are parameters which are associated with the I/O modules selected. In the case of the PRT1-SCU11 these parameters define behaviour with respect to the devices attached to the PRT1-SCU11. They are discussed in the next section.

Example

The Parameter tab of the PRT1-SCU11 is shown in the figure below. It lists the parameters for the selected temperature controller the E5ZN-Extended 2 Channel 11WI/3WO. The parameter captions are listed in the left column and the options can be set in the right column. In order to change settings, double-click the required parameter row with the left mouse button. Depending on the parameter type, either a drop-down list will become available for selection or a value can be entered.

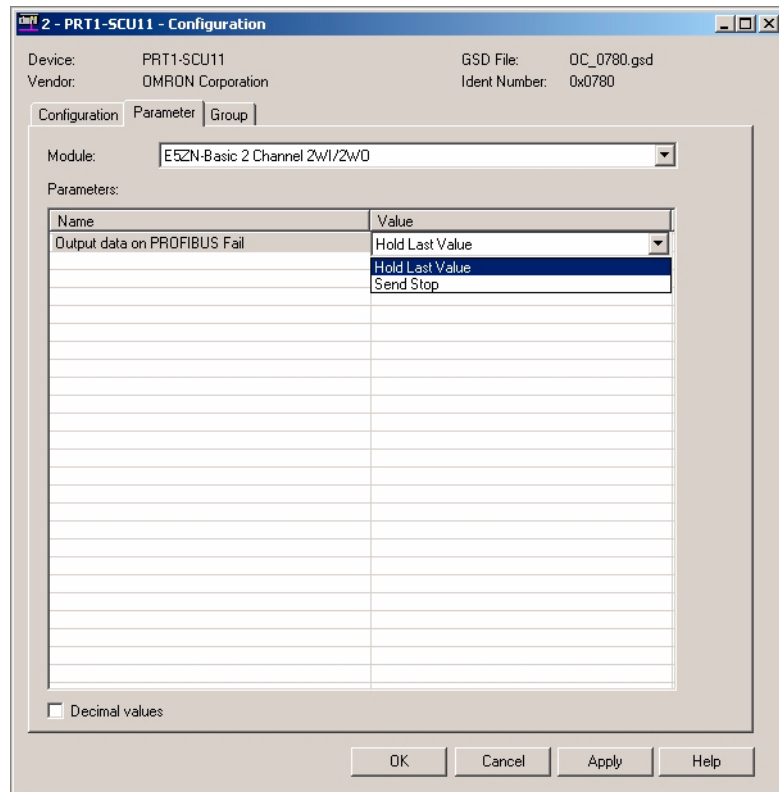

SECTION 3

Operation

This section describes how to operate the PRT1-SCU11 in a network. It will discuss setting up a network, configuring all the connected devices and starting the network. Furthermore, it provides information the I/O data exchange performance and it also provides information on how to monitor a network, using the unit and monitoring the status of the Temperature Controller by using CX-Thermo (not shipped with the PRT1-SCU11).

3-1	Introduction	40
3-2	PROFIBUS Communication	40
3-3	Compoway-F Communication	41
3-3-1	Fixed Communication Blocks	41
3-3-2	Special Operation	42
3-3-3	Compoway-F Parameter Settings	44
3-3-4	Free Communication Blocks	44
3-4	K-Format Communication	48
3-4-1	Fixed Communication Blocks	48
3-4-2	Operation Execute	48
3-4-3	K-Format Parameter Settings	48
3-4-4	Free Communication Blocks	49
3-5	Host Link Communication	50
3-6	Memobus Communication	51
3-6-1	Fixed / Flexible Communication Blocks	51
3-6-2	Memobus Parameter Settings	52
3-7	PROFIBUS Diagnostics	53
3-8	Auxiliary RS-232C interface	54

3-1 Introduction

This section discusses the operational aspects of using the PRT1-SCU11 and the configuration software. The section has been setup, to follow the general process flow of setting up and configuring a network, downloading the configuration, and operating the PROFIBUS network, the Compoway-F, K-Format, Host Link or Memobus network.

The PROFIBUS Master can communicate with the PRT1-SCU11 using fixed communication block and/or Free Communication blocks.

In case Error messages are displayed, while using CX-Profibus, refer to the appropriate manual for more information on errors.

- Note**
1. The maximum number of devices is 15.
 2. The maximum of modules is 18. This number consists of 15 fixed communication blocks, 1 write, 1 read and 1 operation Free Communication block.

3-2 PROFIBUS Communication

As mentioned in the previous section there are two ways of PROFIBUS communication. Communication with fixed communication blocks and Free Communication blocks.

Fixed Communication Blocks

Fixed communication blocks are pre-defined blocks of data to be read/written from/to a device. Fixed communication blocks can not be changed. The most common data can be read/written using fixed communication blocks.

Example

For an E5ZN connected to the PRT1-SCU11 a 2-channel basic fixed I/O block defines the data transfer of 1 Setpoint Value for each channel and 1 Process Value for each channel between the PROFIBUS Master unit and the E5ZN through the PRT1-SCU11.

Free Communication Blocks

Free communication blocks are sent directly to the device connected to the PRT1-SCU11. The PRT1-SCU11 does not interfere with the data contents of the block. This allows Free Communication blocks to be used to access data in a device which can not be accessed through fixed communication blocks. Free Communication Blocks can be used for Compoway-F and the K-Format protocol.

Flexible Communication Blocks

Flexible communication blocks are defined for the Memobus protocol and are a mix between the fixed blocks and the Free Communication blocks. The flexible communication blocks will contain 3 input words and 3 output words, for each of which a target register in the Varispeed F7 Inverter can be defined.

Maximum PRT1-SCU11 PROFIBUS DP I/O Size

The maximum amount of PROFIBUS data the PRT1-SCU11 can handle is 100 words input data and 100 words output data. If more capacity is needed an extra PRT1-SCU11 is required to access additional devices.

- Note** As per PROFIBUS DP definition the I/O data words are sent in Big Endian format, i.e. the high byte is sent first.

3-3 Compoway-F Communication

3-3-1 Fixed Communication Blocks

Fixed communication blocks are pre-defined blocks, which define specific groups of I/O data words. Each device has at least one Fixed communication block for specific status and control words. In the next table an overview of all devices and their communication blocks is listed. In addition to the Input and Output words, a number of I/O modules also provide Special Operations words, which can be used to change the control status of a Temperature Controller, for example from STOP to RUN.

Compoway-F						
Device type	Module name	Output words	Input words	Total output words	Total input words	Number of channels
-	Empty slot (No device)	-	-	0	0	N/A
E5_R	E5_R-Basic 1 channel	SV channel 1	PV-channel 1	1	1	1
	E5_R-Basic 2 channels	SV channel 1 SV channel 2	PV channel 1 PV channel 2	2	2	2
	E5_R-Basic 4 channels	SV channel 1 SV channel 2 SV channel 3 SV channel 4	PV channel 1 PV channel 2 PV channel 3 PV channel 4	4	4	4
	E5_R-Extended 1 channel	SV channel 1 Special operation (See Note)	PV channel 1 MV1 channel 1 MV2 channel 1 Status high word channel 1 Status low word channel 1 Operation execute	2	6	1
	E5_R-Extended 2 channel	SV channel 1 SV channel 2 Special operation (See Note)	PV channel 1 MV1 channel 1 MV2 channel 1 Status high word channel 1 Status low word channel 1 PV channel 2 MV1 channel 2 MV2 channel 2 Status high word channel 2 Status low word channel 2 Operation execute	3	11	2
	E5_R-Extended 4 channels	SV channel 1 SV channel 2 SV channel 3 SV channel 4 Special operation (See Note)	PV channel 1 MV1 channel 1 MV2 channel 1 Status high word channel 1 Status low word channel 1 PV channel 2 MV1 channel 2 MV2 channel 2 Status high word channel 2 Status low word channel 2 PV channel 3 MV1 channel 3 MV2 channel 3 Status high word channel 3 Status low word channel 3 PV channel 4 MV1 channel 4 MV2 channel 4 Status high word channel 4 Status low word channel 4 Operation execute	5	21	4

Compoway-F						
Device type	Module name	Output words	Input words	Total output words	Total input words	Number of channels
E5ZN	E5ZN-Basic 2 channels	SV channel 1 SV channel 2	PV channel 1 PV channel 2	2	2	2
	E5ZN-Extended 2 channels	SV channel 1 SV channel 2 Special operation (See Note)	PV channel 1 MV1 channel 1 MV2 channel 1 Status high word channel Status low word channel PV channel 2 MV1 channel 2 MV2 channel 2 Status high word channel 2 Status low word channel 2 Operation execute	3	11	2
E5_N	E5_N-Basic 1 channel	SV channel 1	SV channel 1	1	1	1
	E5_N-Extended 1 channel	SV channel 1 Special operation (See Note)	PV channel 1 MV1 channel 1 MV2 channel 1 Status high word channel 1 Status low word channel 1 Operation execute	2	6	1

Note The Special operation word is explained in the section below.

3-3-2 Special Operation

Command Word

The Special Operation word format is shown in the figure below. It contains the Command Code, and the Channel Number. The Command Code specifies the action to be performed, the Channel Number specifies channel to which the action will apply. Both the Command Code and Channel Number coding are listed in the table below.

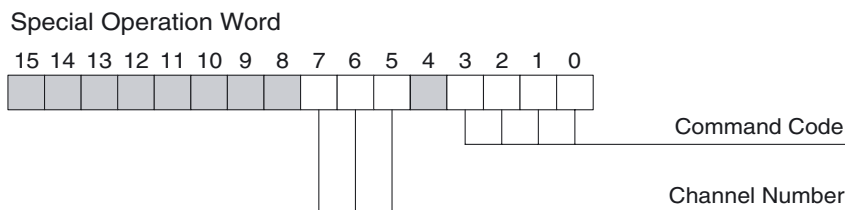

Since the Command Word will be part of the cyclic data exchange, a mechanism in the PRT1-SCU11 is used to send this word to the targeted device only when needed. The PRT1-SCU11 will transfer the command word to the target device up on a change of one or more of the bits in the contents of the Command Word.

Response Word

Once the command has been sent, the response from the device is placed in the PROFIBUS input Operation Execute word. The format of the response is shown in the figure below. the Operation Execute word contains the Command Code, the Channel Number as well as an Error Code bit. If the Error bit (bit 4) is set, an error has occurred in the communication with the targeted device.

Operation Execute Word

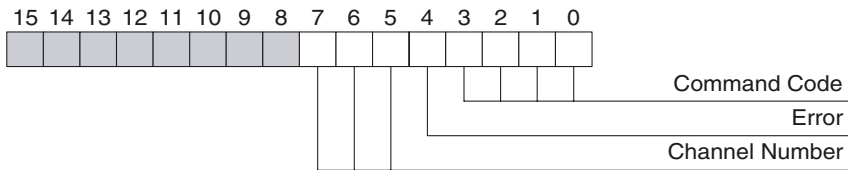

An overview of all the Command Codes, Channel Numbers and Error Codes is given in the table below.

Bit group name	Binary Value	Value description
Command code	0000	Clear command
	0001	Run
	0010	Stop
	0011	AT Cancel
	0100	AT Execute
	0101	Auto
	0110	Manual
	0111-1111	Reserved
Channel numbers	000	Channel 1
	001	Channel 2
	010	Channel 3
	011	Channel 4
	100-110	Not supported
	111	All channels
Error code, one bit	0	No error
	1	Error <ul style="list-style-type: none"> • Not supported command number • Not supported channel number • Command execution failed • Communication with Temperature Controller fails

Handshaking

In order to prevent an overflow of commands being sent to one or more devices, the user must implement a simple handshaking mechanism in the PROFIBUS DP Master unit.

- When no command is to be sent to a device, set the Special Operation Word in the PROFIBUS DP Master to 0. The PRT1-SCU11 will respond by setting the Operation Execute word to 0.
- When a command must be sent to a device, set the Command Code and the Channel Number. For another Special Operation command to be sent, the user must first wait for the Operation Execute word to change to a non-zero value, indicating the completion of the first Special operation command.

3-3-3 Compoway-F Parameter Settings

For the Fixed Communication blocks the user can define behaviour of the PRT1-SCU11 on the Compoway-F communication in case the PROFIBUS communication fails.

PROFIBUS Communication Fails

In case the PROFIBUS communication fails, there are two options for the PRT1-SCU11 to handle this, as defined by the a user.

- The PRT1-SCU11 can send a stop command to one or more of the devices, causing the control cycle to stop.
- The Temperature Controller can Hold the last received Setpoint Value.

This behavior can be selected in CX-Profibus when configuring the PROFIBUS DP Master unit, see the example in the figure below.

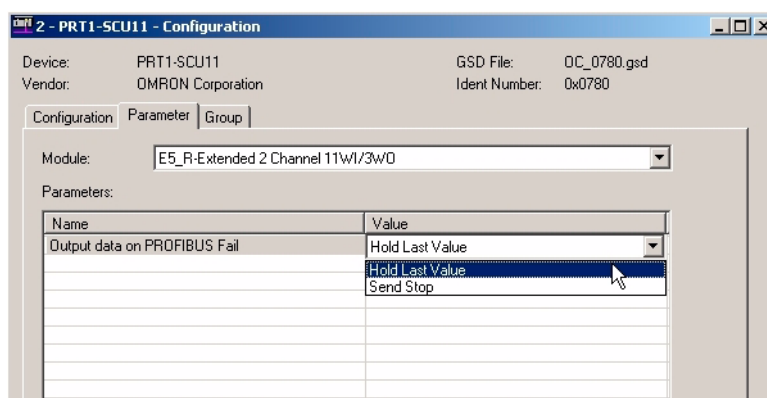

This setting can be defined for every individual Temperature Controller and will be sent to the PRT1-SCU11 as part of the PROFIBUS DP Set_Prm message.

3-3-4 Free Communication Blocks

With Free Communication blocks it is possible to read data, write data or send an operation instruction directly from or to any parameter in a Compoway-F device. With Free Communication blocks, however, the commands have to be assembled by the PROFIBUS Master system. The user also has to provide a simple handshaking mechanism to prevent too many commands being sent. The PRT1-SCU11 uses the contents of the Free Communication block to assemble a Compoway-F mini-FINS command, which is sent to the device.

The Free Communications blocks can be selected as I/O modules from the GSD file. Three Free Communication blocks are defined for Compoway-F and can be used to configure the PRT1-SCU11.

1. Read for reading one parameter defined in the device.
2. Write for writing one parameter defined in the device.
3. Operation for executing any operation defined in device.

Note The Free Communication blocks do not require the user to make parameter settings.

In the next table an overview is presented on how the Free Communication blocks are composed for several different device types.

Compoway-F					
Device type	Module name	Output words	Input words	Total output words	Total input words
E5_N, E5ZN, E5_R	Free comms Read 4 WI / 5 WO	Device address (1 word) Command data (4 words)	Response code (2 words) Read data (2 words)	5	4
	Free comms Write 2 WI / 7 WO	Device address (1 word) Command data (4 words) Write data (2 words)	Response code (2 words)	7	2
	Free comms Operation 2 WI / 3 WO	Device address (1 word) Command data (2 words)	Response code (2 words)	3	2

A Free Communication block always contains a device address (one word with a value in the range between 0000 (hex) and 0063(hex)) and a mini FINS command. The length of the mini FINS command depends on the command type (operation, write or read) to be executed.

Operation Mini FINS Command

The Operation mini FINS command type consists of a command code MRC/SRC, followed by an instruction code, the value of this instruction code is command type dependent. The operation of a mini FINS command is defined as follows.

Device address	Command code MRC/SRC	Instruction code & related information
2 bytes	2 bytes	2 bytes

The response of this command for a correct executing of the command is defined as:

Command code MRC/SRC	Response code
2 bytes	2 bytes

Refer to the operation manual of the targeted Compoway-F device for more commands and detailed information.

Example

To stop control on channel 1 of the E5_R, with address 05, the contents of the Free Communication block must be set to 0005 3005 0101 (hex), or

- Device address: 0005 (hex)
- Command code: 3005 (hex)
- Instruction code: 0101 (hex).

Assuming there is no error, the response is four bytes: 3005 0000 (hex).

Read Mini FINS Command

The Read mini FINS command consists of

- A device address number.
- A command code MRC/SRC.
- A variable area type, indicating the area within the device, from where the parameter must be read.
- A Read start address within the specified area.
- A Bit position within the parameter to be read.
- The Number of bits/bytes to read from the parameter area/location.

This format is shown below.

Device address	Command code MRC/SRC	Variable type	Read start address	Bit position	Number of elements
2 bytes	2 bytes	1 byte	2 bytes	1 byte	2 bytes

The response of this command for a correct executing of the command is defined as:

Command code MRC/SRC	Response code	Data
2 bytes	2 bytes	4 bytes

Refer to the operation manual of the Compoway-F device for more detail regarding the read mini FINS command.

- Note**
1. The actual data to be written to the device consists of one double word. If a CS1/CJ1 PLC is used to assemble the Write command, the data will be swapped before sending it over PROFIBUS, due to the communication formats of both Compoway-F and PROFIBUS. The PLC program must swap these words before the data can be transmitted.
 2. For CX-Programmer 5.0 or higher OMRON provides function blocks to implement the assembly of the Free Communication Read command. When processing the response this function block will perform the word swapping automatically. Refer to *Appendix B Function Block Programming* for more details.

Example

Reading the internal setpoint from an E5ZN (device 2), channel 1 (start address 2, 1 element to read) is done with the command:
 0002 0101 C1 0002 00 0001(hex).
 The response is (no error occurred): 0101 0000 0000 0000 0000 0000(hex).

Write Mini FINS Command

The Write mini FINS command consists of

- A device address number.
- A command code MRC/SRC.
- A variable area type, indicating the area within the device, to where the parameter must be written.
- A Read start address within the specified area.
- A Bit position within the parameter to be read.
- The Number of bits/bytes to read from the parameter area/location.
- The data to be written.

This format is shown below.

Device address	Command code MRC/SRC	Variable type	Write start address	Bit position	Number of elements	Element1
2 bytes	2 bytes	1 byte	2 bytes	1 byte	2 bytes	4 bytes

The response of this command for a correct executing of the command is defined as:

Command code MRC/SRC	Response code
2 bytes	2 bytes

1. Refer to the operation manual of the Compoway-F device for more detail regarding the read mini FINS command.
The actual data written to the Temperature Controller consists of one double word. Due to the communication formats of both Compoway-F and PROFIBUS, the data will end up as two swapped words in a CS1/CJ1 PLC, when the CS1/CJ1W-PRM21PROFIBUS Master is used. The PLC program must swap these words before the data can be used.
2. For CX-Programmer 5.0 or higher OMRON provides function blocks to implement the assembly of the Free Communication Write command. When processing the response this function block will perform the word swapping automatically. Refer to *Appendix B Function Block Programming* for more details.

Example

Writing the lower limit of the setpoint an E5ZN (device 2), channel 1 is done with the command: 0002 0102 C1 0003 00 0001 0000 0005(hex).
The response is (no error occurred): 0102 0000(hex).

Free Communication Blocks

A write or operation command will be sent to the device when the command is changed from zero's to the correct data. When the command data is set to zero, the response data will also be cleared. The read type command blocks are sent every Compoway-F cycle.

Broadcast

Broadcasting can be used for operations and writes. If the device address is set to 00FF(hex), a broadcast is sent to all devices using XX broadcast. The response code will be filled with a response to indicate that the command has been sent to the devices.

Note It is recommended to restrict the Free Communication blocks to the end of the I/O configuration. Placing a Free Communication block in the middle of other modules is allowed, but it will influence the device number of other modules. The device number is affected due to the fact that the slot number is a representation of the device number.

Example

Configuring 2 x E5ZN basic modules and a Free Communication write block:
If there is no device for a device address between two existing consecutive device addresses, the empty slot module must be used. The slot number represents the device address.

Slot number	Recommended		Not recommended	
	Module	Device number	Module	Device number
1	E5ZN Basic	1	E5ZN Basic	1
2	E5ZN Basic	2	Free communication write block	--
3	Free communication write block	--	E5ZN Basic	3

Note The PROFIBUS Configuration for this slave is limited to 100 words input and 100 words output.

3-4 K-Format Communication

3-4-1 Fixed Communication Blocks

The K-Format protocol supports Fixed Communication blocks to allow easy configuration for a number of I/O parameters, supported by the E5AK / E5EK intelligent Digital Controllers. In the next table an overview of the Fixed Communication blocks is listed.

K-Format						
Device type	Module name	Output words	Input words	Total output words	Total input words	Number of channels
-	Empty slot (No device)	-	-	0	0	N/A
E5AK/ E5EK	E5_K-Basic 5WI/2WO	SV channel 1 Operation Execute (See Note)	PV channel 1 SV channel 1 Status A group Status B group Special Operation	2	5	1
	E5_K-Extended 5WI/4WO	SV channel 1 Alarm value 1 Alarm Value 2 Operation Execute (See Note)	PV channel 1 SV channel 1 Status A group Status B group Special Operation	4	5	1

Note The Special operation word is explained in the section below.

3-4-2 Operation Execute

The Operation Execute word can be used to Start or Stop a control cycle in the E5AK / E5EK Controller. The command options are shown below.

Command	Value (See Note)	Description
Run	0000	Start Control cycle.
Stop	0001	Stop Control Cycle.

Note Other values for Operation Execute are not supported.

3-4-3 K-Format Parameter Settings

For the Fixed Communication blocks the user can define behaviour of the PRT1-SCU11 on the K-Format communication in case the PROFIBUS communication fails.

PROFIBUS Communication Fails

In case the PROFIBUS communication fails, there are two options for the PRT1-SCU11 to handle this, as defined by the a user.

- The PRT1-SCU11 can send a stop command to the device, causing the control cycle to stop.
- The E5AK / E5EK can Hold the last received Setpoint Value.

This behavior can be selected in CX-Profibus when configuring the PROFIBUS DP Master unit, see the example in the figure below.

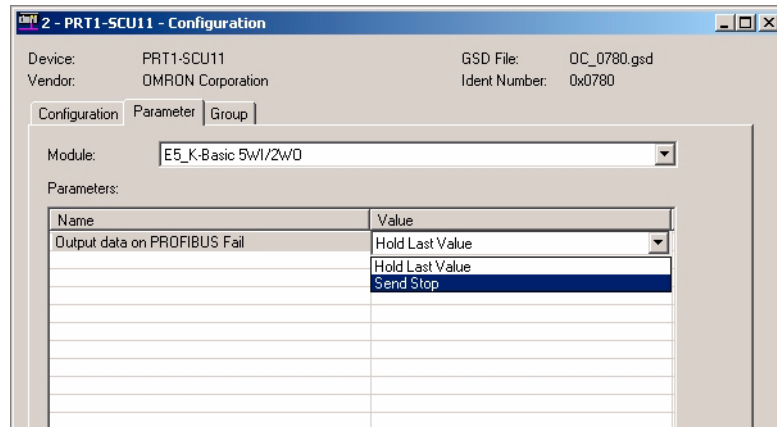

This setting can be defined for every individual Temperature Controller and will be sent to the PRT1-SCU11 as part of the PROFIBUS DP Set_Prm message.

3-4-4 Free Communication Blocks

For the K-Format protocol one Free Communication Block is available, which has however, a different format as compared to the Free Communication Block for Compoway-F. The one Free Communication block allows implementation of Read, Write and special Operation type of commands.

Free Communication Block Format

The Free Communication block reserves 3 words of input data and 3 words of output data. The output format is shown below.

Device address	Reserved	Command type	Parameter Number/ Command code	Data
1 byte	1 byte	1 byte	1 byte	2 byte

The table below lists the message parameters.

Message parameter	Description
Device address	The address number of the target device.
Reserved	A reserved byte, which will be ignored by the PRT1-SCU11
Command type	A command type code 1 = Read command 2 = Write command 3 = Special command 4 ~ FF = Invalid command
Parameter Number / Command Code	Refer to the E5AK / E5EK Operation Manual. In case the Command type is set to 1 or 2, use the Parameter number to specify the parameter to be read or written. In case the Command type is set to 3, use the Command code to define the Special Operation.
Data	Data to be written. The PRT1-SCU11 will ignore this part in case of a Read command or a special operation command.

The input format is shown below.

Device address	End code	Command type	Parameter Number/ Command code	Data
1 byte	1 byte	1 byte	1 byte	2 byte

The table below lists the message parameters.

Message parameters	Description
Device address	The address number of the target device.
End code	Indicates failure or success of the command transmission. If the End code is not equal to 0, the data part must be considered invalid.
Command type	A command type code 1 = Read command 2 = Write command 3 = Special command 4 ~ FF = Invalid command This is the same as sent to the device via the output data.
Parameter Number / Command Code	Refer to the E5AK / E5EK Operation Manual. In case the Command type is set to 1 or 2, use the Parameter number to specify the parameter to be read or written. In case the Command type is set to 3, use the Command code to define the Special Operation.
Data	Data read from or written to the E5AK / E5EK Controller.

3-5 Host Link Communication

In the following table the fixed communication blocks for Host Link communication are listed.

Host Link					
Device type	Module name	Output words	Input words	Total output words	Total input words
-	Empty slot (No device)	-	-	0	0
R88A-MCW151-E	"MCW151 Host Link 5 IW/5 OW"	VR(5) (Status word) VR(6) - VR(10)	VR(0) - VR(4)	5	5
	"MCW151 Host Link 10 IW /10 OW"	VR(10) (Status word) VR(11) - VR(20)	VR(0) - VR(9)	10	10
	"MCW151 Host Link 15 IW / 15 OW"	VR(15) (Status word) VR(16) - VR(30)	VR(0) - VR(14)	15	15

The required data on VR-memory address can be programmed in the R88A-MCW151-E. For more detailed information refer to the R88A-MCW151-E Operation Manual.

The status of the PROFIBUS communication can be checked by the R88A-MCW151-E through the R88A-MCW151-E status word (see figure below). This word is sent by the PRT1-SCU11 to the R88A-MCW151-E. In case PROFIBUS communication fails, the first bit of the status word will be set to

OFF. If the PROFIBUS communication is active the same bit will be set to ON, regardless the number of I/O communication words.

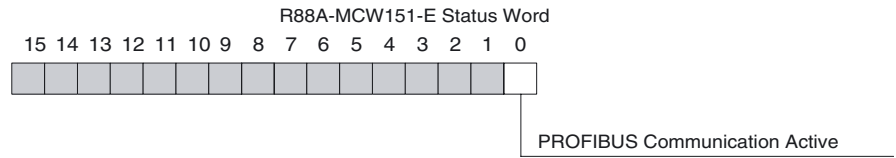

3-6 Memobus Communication

3-6-1 Fixed / Flexible Communication Blocks

The Memobus protocol supports Fixed Communication blocks to allow easy configuration for a number of I/O parameters, supported by the E5AK / E5EK intelligent Digital Controllers. In the next table an overview of the Communication blocks is listed.

Memobus					
Device type	Module name	Output words	Input words	Total output words	Total input words
-	Empty slot (No device)	-	-	0	0
F7 Inverter	Memobus Fixed 3WI/3WO (Fixed)	Command Register Frequency Register Voltage Register (See Note 1)	Status Register Frequency Register Voltage Register (See Note 1)	3	3
	Memobus 3WI/3WO (Flexible)	Register 1 Register 2 Register 3 (See Note 2)	Register 1 Register 2 Register 3 (See Note)	3	3

- Note**
1. The addresses of these registers are fixed in the PROFIBUS parameter message. They can not be changed by the user.
 2. The user can define each of the addresses of the registers in the Input and Output area. This must be done upon configuring the PROFIBUS DP Master unit, see section 2-6 *Configuring the PROFIBUS DP network*.

3-6-2 Memobus Parameter Settings

During configuration of the PROFIBUS Master unit the user must set a number of parameters, depending on the selected Communication block. The figure below shows the selection options for a Fixed Communication Block.

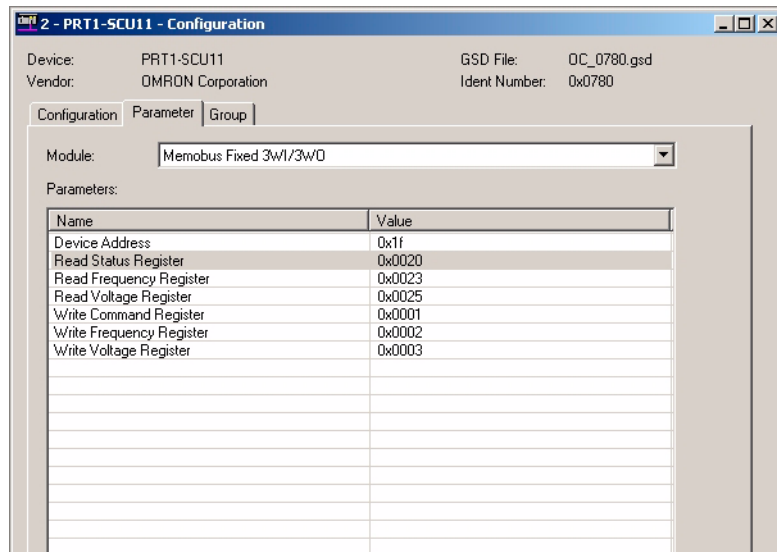

The parameter options are listed in the table below.

	Parameter name	Range (Hex)	Description
Fixed Comm. Block	Device Address	00 ~ 1F	Defines the Memobus address of the device to exchange the I/O data of this module with.
	Read Status Register	0020	Address of the status register (Fixed).
	Read Frequency Register	0023	Address of the Actual Frequency register (Fixed).
	Read Voltage Register	0025	Address of the Actual Voltage register (Fixed).
	Write Command Register	0001	Address of the Command register (Fixed).
	Write Frequency Register	0002	Address of the Required Frequency register (Fixed).
	Write Voltage Register	0003	Address of the Required Voltage register (Fixed).
Flexible Comm. Block	Device Address	00 ~ 1F	Defines the Memobus address of the device to exchange the I/O data of this module with.
	Read Register Address One	0000 ~ FFFF	Address of first register to read from.
	Read Register Address Two	0000 ~ FFFF	Address of second register to read from.
	Read Register Address Three	0000 ~ FFFF	Address of third register to read from.
	Write Register Address One	0000 ~ FFFF	Address of first register to write to.
	Write Register Address Two	0000 ~ FFFF	Address of second register to write to.
	Write Register Address Three	0000 ~ FFFF	Address of third register to write to.

3-7 PROFIBUS Diagnostics

The PRT1-SCU11 provides extended diagnostics over PROFIBUS to notify the PROFIBUS DP Master of the Unit's status and the status of the RS-422A/RS-485 communication. These extended diagnostics are sent to the Master unit via a PROFIBUS Diagnostics message. These messages are only sent up on occurrence of the error or status event.

A PROFIBUS Diagnostics message will contain 6 standard diagnostics bytes, followed by the Extended diagnostics bytes, in case any extended diagnostics data is available. The extended diagnostics bytes as produced by the PRT1-SCU11 are shown below.

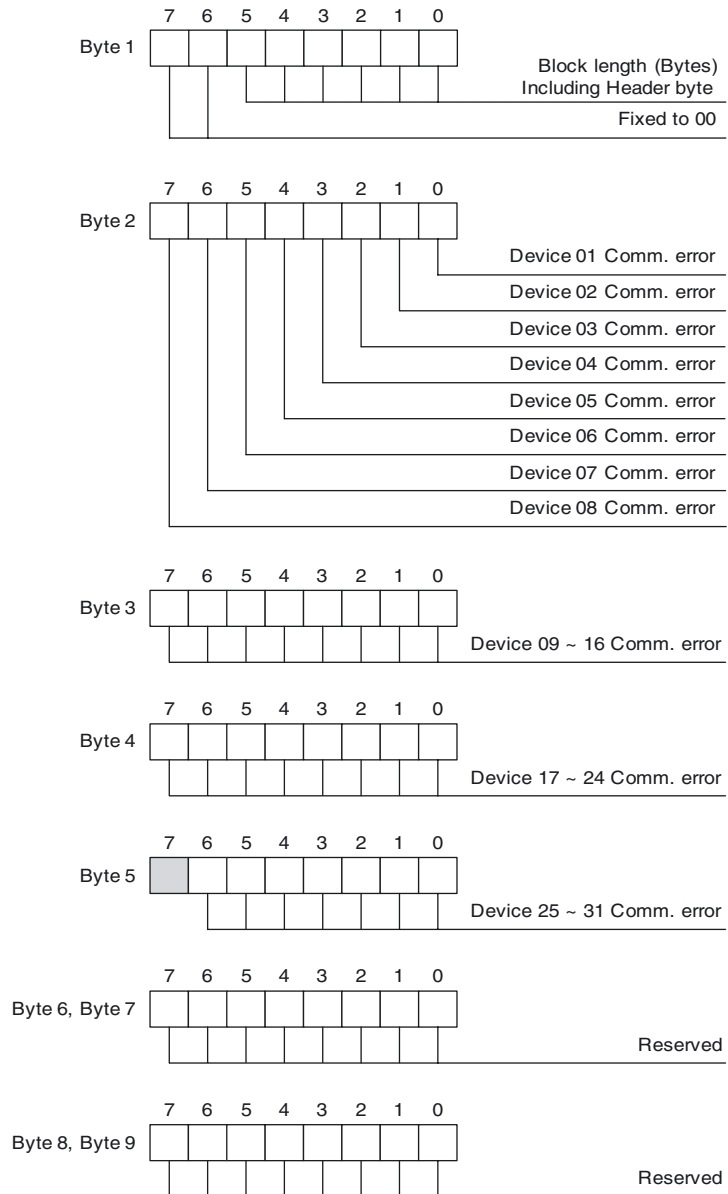

- Note**
1. Byte 1 in the figure above represents the 7th byte in a diagnostics message. The first 6 bytes (not shown here) are standard diagnostics.
 2. If a bit flag in byte 2 to 5 is ON, the corresponding device on the RS-422A/RS-485 network is not responding or it has reported a communication error.

3-8 Auxiliary RS-232C interface

The PRT1-SCU11 provides an RS-232C interface, behind a cover lid on the front of the Unit. This interface allows a user to connected an IBM compatible computer with a serial port and send and receive data to a Compoway-F, or K-Format device using the software package CX-Thermo.

Equally, when Memobus has been selected as the protocol, the RS-232C interface can be used to transfer commands from CX-Drive and the Varispeed F7 Inverter.

Using CX-Thermo

Before using CX-Thermo DIP-switch 4 must be set on, a group of four DIP-switches is located on the front of the PRT1-SCU11 Unit.

Note CX-Thermo is not shipped with the PRT1-SCU11.

 **WARNING** When DIP-switch 4 is switched on, the PRT1-SCU11 will stop the data exchange with the PROFIBUS Master. The PROFIBUS DP interface will stay inactive until switch 4 is switch off.

When DIP-switch 4 is set on:

- The diagnostics indicates Slave Not_Ready.
- FERR LED is switched off.
- COMM LED starts flashing.
- FCOM start flashing.
- BF LED is switched off.

To connect with the PRT1-SCU11 use an auxiliary RS-232C compatible interface on an IBM compatible computer and a standard Omron RS-232C PLC cable e.g. (CS1W-CN226).

Note The interface connection is not galvanically isolated.

The baud rate settings are the same as used for the Compoway-F interface, as set through the associated DIP-switches.

To connect with the unit use the second button in the menu, starting from the left, see figure below.

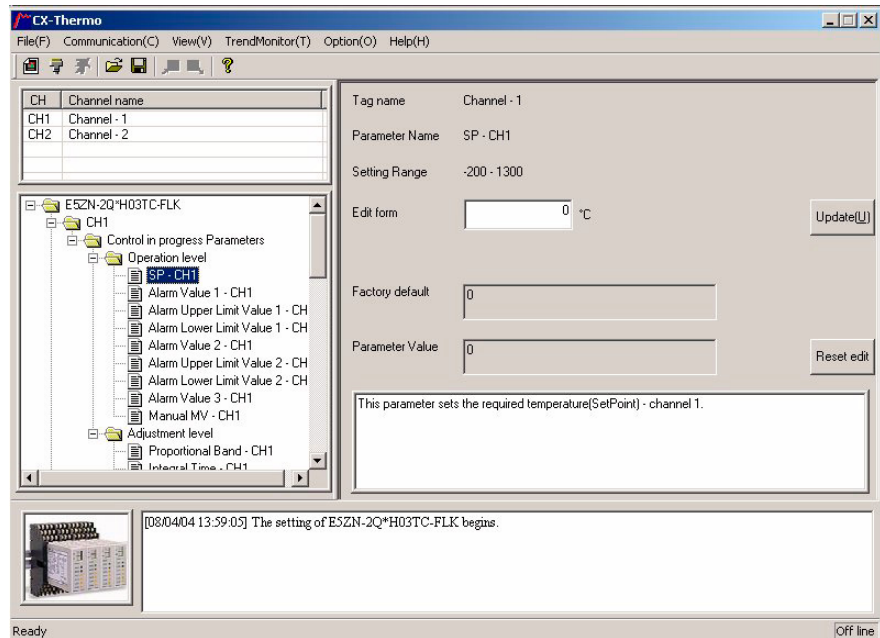

When connected with CX-Thermo you can configure the required Temperature Controller. For detailed information please use the ThermoTool online help and read the manual of the used Temperature Controller.

Note Make sure that the baud rate settings in CX-Thermo is the same as selected on the PRT1-SCU11 with DIP-switch 1 and 2. It is required to use the following communication format:

- Data length: 7 bits
- Stop bit length: 2 bits
- Parity: even

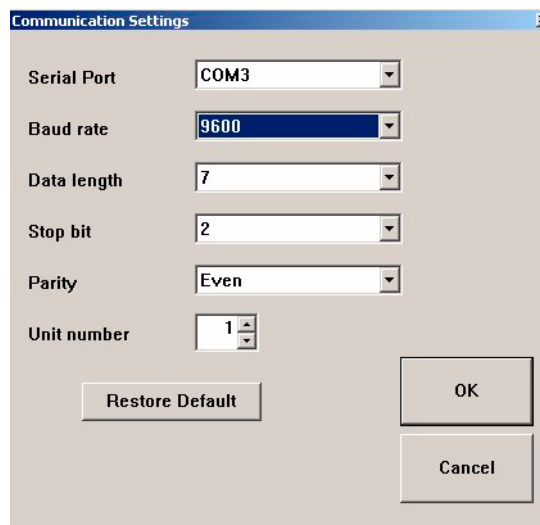

SECTION 4

Troubleshooting and Maintenance

This section describes the troubleshooting procedures and maintenance operations needed to keep the PROFIBUS network optimally working.

4-1	Overview	58
4-2	Troubleshooting Using LED Indicators	58
4-2-1	Unit Led Indicators	58
4-2-2	RS-422A / RS-485 Communication LED Indicators	58
4-2-3	PROFIBUS LED Indicators	59
4-3	Maintenance	60
4-3-1	Cleaning	60
4-3-2	Inspection	60
4-4	Replacing the Unit	61
4-4-1	Replacement Precautions	61

4-1 Overview

The PRT1-SCU11 has several LED indicators, allowing the user to troubleshoot and check the operation.

These LED indicators are:

- RUN, indicates normal operation.
- ERR, fatal error.
- FCOM, RS-422A / RS-485 communication.
- FERR, communication error on RS-422A / RS-485.
- COMM, communication with PROFIBUS Master.
- BF, all communication with the PROFIBUS Master has lost or configuration/parameter error occurs.

The LED's can be categorized into 3 categories.

1. Unit LED indicators.
2. RS-422A / RS-485 Communication LED indicators.
3. PROFIBUS communication LED indicators.

4-2 Troubleshooting Using LED Indicators

4-2-1 Unit Led Indicators

The Unit LED's indicate the status of the PRT1-SCU11. These are the two highest LED's. In the next table there is an overview of all possible LED states of the two Unit LED's. A description of the error and a possible solution to solve the error.

Unit LED's			
RUN	ERR	Description	Solution
Lit	Not lit	Normal operation	-
Not lit	Not lit	<ul style="list-style-type: none"> • Initialization fails. • No power connected to the Unit. 	<ul style="list-style-type: none"> • Restart the module by switching the power off and on, if the problem remains replace the Unit. • Switch power to the Unit.
Not lit	Blinks	Initialization error during startup.	Restart the module by switching the power off and on, if the problem remains replace the Unit.
Not lit	Lit	Fatal error.	Restart the module by switching the power off and on, if the problem remains replace the Unit.

4-2-2 RS-422A / RS-485 Communication LED Indicators

The Unit LED indicators show the status of the communication with Compo-way-F, Host Link, K-Format or Memobus over RS-422A / RS-485. These are the two LED's in the middle. In the next table an overview of all possible LED states of the two LED indicators, a description of the error and a possible solutions to solve the error are presented.

RS-422A / RS-485 LED's			
FCOM	FERR	Description	Solution
Not lit	Not lit	<ul style="list-style-type: none"> No communication over RS-422A / RS-485. Probably a broken wire. Unit has not initialized. Not all devices configured in the PRT1-SCU11 are communicating. No power connected to the Unit. No PROFIBUS communication. Unit has not been initialized with a configuration and cannot proceed with RS-422A/ RS-485 communication. 	<ul style="list-style-type: none"> Check all cables and connections. Switch the Unit off and on, make sure the network configuration has been downloaded. Check Compoway-F, Host Link, K-Format or Memobus addresses, baud rate settings. If baud rate settings are changed a restart must performed Switch power to the Unit. The hardware does not correspond with the configured network in the software.
Lit	Not lit	Communication with RS-422A / RS-485 devices fails, the Unit is unable to establish communication with all devices.	-
Blinks	Not lit	Communication by auxiliary port selected.	<ul style="list-style-type: none"> End your ThermoTools session and switch DIP-switch 4 to off. Switch to the old baud rate settings if these were changed, when baud rate settings are changed a restart must performed.
Not lit	Lit	No communication with RS-422A / RS-485 network.	<ul style="list-style-type: none"> Check Compoway-F, Host Link, K-Format or Memobus addresses, baud rate settings, when baud rate settings are changed a restart must performed. Check all cables and connections.

4-2-3 PROFIBUS LED Indicators

The Unit LED indicators show the status of the communication with PROFIBUS. These are the two lowest LED's. In the next table an overview of all possible LED states of the two PROFIBUS LED indicators, a description of the error and a possible solutions to solve the error are presented.

PROFIBUS LED			
COMM	BF	Description	Solution
Not lit	Not lit	No power connected to the Unit	Switch power to the Unit
Not lit	Lit	No communication with PROFIBUS Master	<ul style="list-style-type: none"> Check if the PROFIBUS Master is running Check all PROFIBUS cables and connections, termination resistor.
Not lit	Blinks	The wrong module selected in the network configuration	<ul style="list-style-type: none"> The hardware does not correspond with the configured network in the software, Check also the PROFIBUS addresses of the Unit
Blinks	Not lit	Compoway-F, K-Format or Memobus communication through the auxiliary port	<ul style="list-style-type: none"> End your ThermoTools / CX-Drive session and switch DIP-switch 4 to off. Switch to the old baud rate settings if these were changed, when baud rate settings are changed a restart must performed
Lit	Not lit	Communication in progress	-

4-3 Maintenance

This section describes the routine cleaning and inspection recommended as regular maintenance.

4-3-1 Cleaning

Clean the PRT1-SCU11 regularly as described below in order to keep it in an optimum operating condition.

- Regularly wipe the Unit with a dry, soft cloth.
- If a spot cannot be removed with a dry cloth, dampen the cloth with a neutral cleaner, wring out the cloth and wipe the Unit.

 **Caution** Never use volatile solvents such as paint thinner, benzene or chemical wipes. These substances could damage the surface of the Unit.

4-3-2 Inspection

Be sure to inspect the system periodically to keep it in optimum operating condition. In general, inspect the system once or twice a year, but more frequently if the system is used in high temperature or high humidity environments or dirty/dusty conditions.

Inspection Equipment

Prepare the following equipment before inspecting the system.

Required Equipment

Phillips type screwdriver, multimeter, alcohol, and a clean cloth.

Optional Test Equipment

Depending on system conditions, a synchroscope, oscilloscope, thermometer or hygrometer (to measure humidity) might be needed.

Inspection Procedure

Check the items in the following table and correct any that are below standard.

	Item	Standard	Equipment
Environmental conditions	Ambient temperature	0° C to 55° C	Thermometer
	Ambient humidity	10% to 90%	Hygrometer
	Dust/dirt accumulation	None	---
Installation	Are the units installed securely?	No looseness	---
	Are the communications connectors fully inserted?	No looseness	---
	Are the external wiring screws tight?	No looseness	---
	Are the connecting cables undamaged?	No damage	---

4-4 Replacing the Unit

4-4-1 Replacement Precautions

The PRT1-SCU11 is a network device. If the Unit is damaged, it will effect the entire Network, so always ensure repairs are undertaken immediately. It is recommended to have a spare PRT1-SCU11 on hand so that repairs may be conducted quickly.

Replacement Precautions

Observe the following precautions when replacing the Unit.

- Always turn OFF the power before replacing the Unit.
- Ensure that the new Unit is not faulty.
- If a poor connection is suspected of causing the malfunction, clean the connectors using a clean, soft cloth and industrial-grade alcohol. Remove any lint or threads left from the cloth, and remount the Unit.
- When returning a faulty unit for repair, always attach a detailed fault report to the unit and return it to the nearest OMRON dealer.

- Note**
1. In order to prevent faulty operation be sure to turn off the power to all master and slave devices before replacing the Unit.
 2. When replacing the Unit, do not reconnect it to the Network before carrying out the procedures listed below.

Appendix A

Memory Mapping

A-1 Memory Mapping for Compoway-F Devices

The table below lists the Mapping of individual parameters in the Basic and Extended on to the applicable Temperature Controller variable areas.

	Parameter	Read/Write	MRC/SRC	E5_N	E5ZN		E5_R			
					Channel 1	Channel 2	Channel 1	Channel 2	Channel 3	Channel 4
Basic block	SV	W	0102	C1:0003	C1:0003	C1:0103	C1:0003	C1:0103	C1:0203	C1:0303
	PV	R	0101	C0:0000	C0:0000	C0:0100	C0:0000	C0:0100	C0:0200	C0:0300
Extended block	SV	W	0102	C1:0003	C1:0003	C1:0103	C1:0003	C1:0103	C1:0203	C1:0303
	Special Operation Command	W	See table below							
	PV	R	0101	C0:0000	C0:0000	C0:0100	C0:0000	C0:0100	C0:0200	C0:0300
	Status	R	0101	C0:0001	C0:0001	C0:0101	C0:0001	C0:0101	C0:0201	C0:0301
	MV1	R	0101	C0:0004	C0:0004	C0:0104	C0:0004	C0:0104	C0:0204	C0:0304
	MV2	R	0101	C0:0005	C0:0005	C0:0105	C0:0005	C0:0105	C0:0205	C0:0305
	Special Operation Executed	R	See table below							

The table below lists the command codes used by the PRT1-SCU11 to translate the Special Operation Commands to mini FINS messages.

	Parameter (See Note)	MRC/SRC	Cmd Code	E5_N	E5ZN		E5_R			
					Channel 1	Channel 2	Channel 1	Channel 2	Channel 3	Channel 4
Special Operation	Run / Stop	3005	01	00 / 01	00 / 01	10 / 11	00 / 01	10 / 11	20 / 21	30 / 31
		3005	01	NA	F0 / F1		F0 / F1			
	AT Cancel/ Execute	3005	03	00 / 01	00 / 01	10 / 11	01 and 0A			
		3005	03	NA	F0 / F1		Refer to E5AR/E5ER Digital Controller Users Manual (Z182-E1-□) for details			
	Auto/ Manual	3005	09	NA	00 / 01	10 / 11	00 / 01	10 / 11	20 / 21	30 / 31
		3005	09	NA	F0 / F1		F0 / F1			

Note Each type of command lists two possible channel addressing methods: the first row specifies commands for individual channels, the second row the command for all channels.

A-2 Parameter / Command Mapping for K-Format Devices

The table below lists the Mapping of individual parameters in the Basic and Extended blocks on to the E5AK/E5EK Intelligent Digital Controller. Refer to the E5AK and E5EK Operation Manuals (H083-E1-□, H085-E1-□) for more information.

Parameter		Read/Write	Parameter Number	Remarks
Basic	Setpoint	W	01	
	Special operation	W	--	Special Command is used to initiate Run or Stop. <ul style="list-style-type: none"> • 0000 = Run • 0001 = Stop
	PV monitor	R	00	
	SP monitor	R	01	
	Status A group	R	--	Special Command is used to read Status A/Status B. <ul style="list-style-type: none"> • 0000 = Status group A • 0001 = Status group B
	Status B group	R		
	Operation Execute	R	--	Response to Special Operation is returned.
Extended block	Setpoint	W	01	
	Special operation	W	--	Special Command is used to initiate Run or Stop. <ul style="list-style-type: none"> • 0000 = Run • 0001 = Stop
	Alarm Value 1	W	02	
	Alarm Value 2	W	03	
	PV monitor	R	00	
	SP monitor	R	01	
	Status A group	R	--	Special Command is used to read Status A/Status B. <ul style="list-style-type: none"> • 0000 = Status group A • 0001 = Status group B
	Status B group	R		
Operation Execute	R	--	Response to Special Operation is returned.	

A-3 Parameter / Command Mapping for Memobus Devices

The table below lists the Mapping of individual parameters in the Fixed and Flexible I/O blocks on to the OYMC Varispeed F7 Inverter. Refer to the F7 Inverter's Operation Manual (YEG-TOE-S616-55.1-OY) for more information.

Parameter		Read/ Write	Register Number (Hex)	Remarks
Fixed block	Command register	W	0001	
	Frequency register	W	0002	
	Voltage register	W	0003	See Note
	Status register	R	0020	
	Frequency register	R	0023	
	Voltage register	R	0025	
Flexible block	Write register 1	W	0000 ~ FFFF	The registers to read/write can be selected by the user when setting up the PROFIBUS I/O configuration. An invalid register address selection (i.e. non-existent or read-only) will result in a Memobus error.
	Write register 2	W	0000 ~ FFFF	
	Write register 3	W	0000 ~ FFFF	
	Read register 1	R	0000 ~ FFFF	
	Read register 2	R	0000 ~ FFFF	
	Read register 3	R	0000 ~ FFFF	

Note Being able to write to the voltage register, a special firmware version - VSF108981 - for the Varispeed F7 Inverter is required. Contact your supplier on how to obtain this firmware upgrade.

Appendix B

Function Block Programming

B-1 Introduction

In order to facilitate the data transfer to and from Temperature Controllers from a CS1/CJ1W-PRM21 PROFIBUS DP Master via the PRT1-SCU11, OMRON provides a number of PLC Function Blocks. These function blocks can be used in the CS1/CJ1 PLC program to assemble the output data or extract the input data from the CS1/CJ1W-PRM21 PROFIBUS Master I/O data areas. This appendix describes these function blocks.

Note Function Blocks are only supported by CX-Programmer version 5.0 and higher.

B-2 Basic / Extended Function Blocks

A total of 10 function blocks are provided for the basic and extended I/O configuration blocks for the E5_N, E5ZN and E5_R Temperature controllers. The table below lists the specifics of these function blocks.

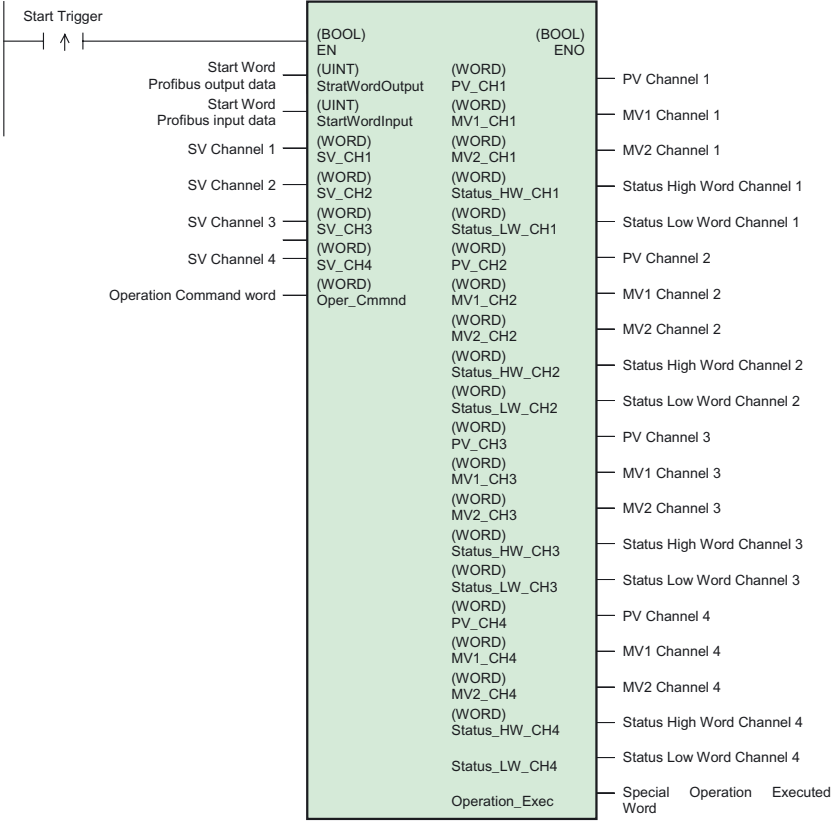
Item	Description
Basic function	Writes the SV/Operation command and reads the PV/MV/Status/Operation Executed word.
Symbol	<div style="text-align: center;">  </div> <p>Note Only the function block for a 4 channel E5_R is shown. The other function blocks are limited versions of this one.</p>

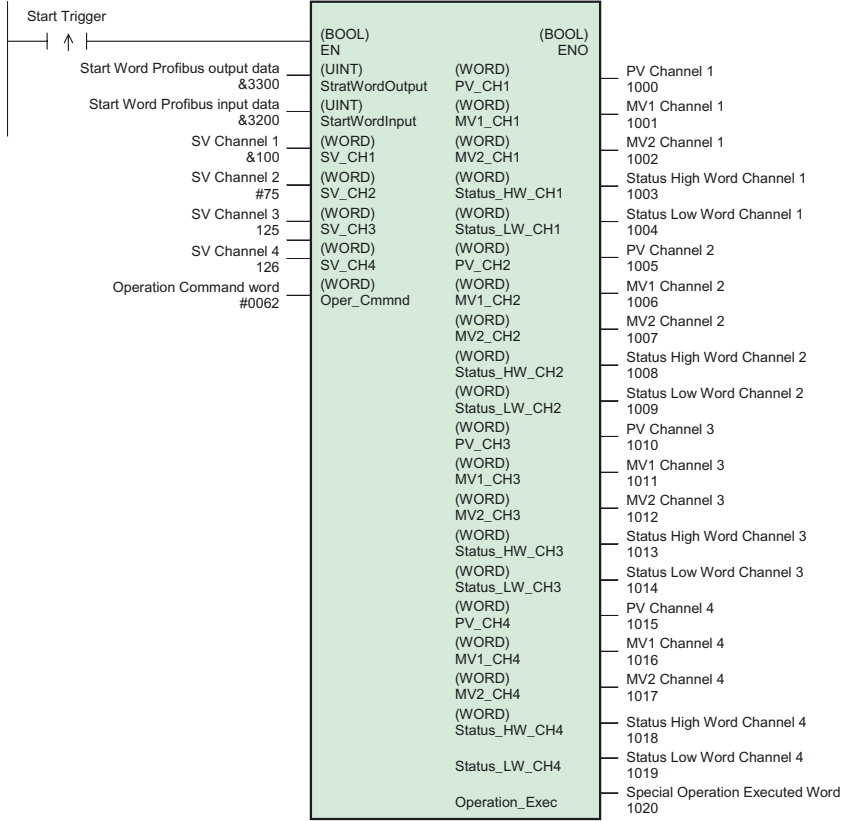
Item	Description
File name	PRT1_SCU11_E5_N_Basic_1CH.cxf PRT1_SCU11_E5_N_Extended_1CH.cxf PRT1_SCU11_E5_R_Basic_1CH.cxf PRT1_SCU11_E5_R_Basic_2CH.cxf PRT1_SCU11_E5_R_Basic_4CH.cxf PRT1_SCU11_E5_R_Extended_1CH.cxf PRT1_SCU11_E5_R_Extended_2CH.cxf PRT1_SCU11_E5_R_Extended_4CH.cxf PRT1_SCU11_E5ZN_Basic_2CH.cxf PRT1_SCU11_E5ZN_Extended_2CH.cxf
Function description	<ul style="list-style-type: none"> Writes SV/Operation command to the CS1/CJ1W-PRM21 PROFIBUS Master I/O addresses allocated to the targeted Temperature Controller. Reads PV/MV/Status/Operation Executed words from the CS1/CJ1W-PRM21 PROFIBUS Master I/O addresses allocated to the targeted Temperature Controller.
EN Input condition	Connect EN to an OR between an upwardly differentiated condition for the start trigger and the BUSY output from the Function Block.
Restrictions on Input variables	<ul style="list-style-type: none"> Always use an upwardly differentiated condition for the EN. If the Input variables are out of range, the ENO flag will turn OFF and the Function Block will not be processed.
Application example	 <p>The diagram illustrates the input and output connections for a 4-channel E5_R function block. On the left, the inputs are: Start Trigger (upwardly differentiated), Start Word Profibus output data (&3300), Start Word Profibus input data (&3200), SV Channel 1 (&100), SV Channel 2 (#75), SV Channel 3 (125), SV Channel 4 (126), and Operation Command word (#0062). On the right, the outputs are: ENO (Boolean), PV Channel 1 (1000), MV1 Channel 1 (1001), MV2 Channel 1 (1002), Status High Word Channel 1 (1003), Status Low Word Channel 1 (1004), PV Channel 2 (1005), MV1 Channel 2 (1006), MV2 Channel 2 (1007), Status High Word Channel 2 (1008), Status Low Word Channel 2 (1009), PV Channel 3 (1010), MV1 Channel 3 (1011), MV2 Channel 3 (1012), Status High Word Channel 3 (1013), Status Low Word Channel 3 (1014), PV Channel 4 (1015), MV1 Channel 4 (1016), MV2 Channel 4 (1017), Status High Word Channel 4 (1018), Status Low Word Channel 4 (1019), and Special Operation Executed Word (1020). The central block lists the data types for each input and output: EN (BOOL), ENO (BOOL), StratWordOutput (UJINT), StartWordInput (UJINT), SV_CH1-4 (WORD), Oper_Cmmnd (WORD), PV_CH1-4 (WORD), MV1_CH1-4 (WORD), MV2_CH1-4 (WORD), Status_HW_CH1-4 (WORD), Status_LW_CH1-4 (WORD), and Operation_Exec (WORD).</p> <p>Note Only the function block for a 4 channel E5_R is shown. The other function blocks are limited versions of this one.</p>

The table below lists the Input and Output variables for the basic / extended function blocks.

	Name	Variable name	Data type	Default	Range	Description
Input variables	EN	EN	BOOL			1 (ON): Function block started 0 (OFF): Function block not started
	Start Word PROFIBUS Output data	StartWordOutput	UINT	3000		Start Word of PROFIBUS Output data in PROFIBUS Master Output data area.
	Start Word PROFIBUS Input data	StartWordInput	UINT	3010		Start Word of PROFIBUS Input data in PROFIBUS Master Input data area.
	SV values	SV_CH1	WORD	0		SV Channel 1
		SV_CH2	WORD	0		SV Channel 2
		SV_CH3	WORD	0		SV Channel 3
SV_CH4		WORD	0		SV Channel 4	
Operation Command	Oper_Cmmnd	WORD	0		Special Operation Executed word	
Output variables	ENO	ENO	BOOL			1 (ON): Function block processed normally 0 (OFF): Function block not processed or ended in an error
	Process variables	PV_CH1	WORD			PV Channel 1
		MV1_CH1	WORD			MV1 Channel 1
		MV2_CH1	WORD			MV2 Channel 1
		Status_HW_CH1	WORD			Status High Word Channel 1
		Status_LW_CH1	WORD			Status Low Word Channel 1
		PV_CH2	WORD			PV Channel 2
		MV1_CH2	WORD			MV1 Channel 2
		MV2_CH2	WORD			MV2 Channel 2
		Status_HW_CH2	WORD			Status High Word Channel 2
		Status_LW_CH2	WORD			Status Low Word Channel 2
		PV_CH3	WORD			PV Channel 3
		MV1_CH3	WORD			MV1 Channel 3
		MV2_CH3	WORD			MV2 Channel 3
		Status_HW_CH3	WORD			Status High Word Channel 3
		Status_LW_CH3	WORD			Status Low Word Channel 3
		PV_CH4	WORD			PV Channel 4
		MV1_CH4	WORD			MV1 Channel 4
		MV2_CH4	WORD			MV2 Channel 4
		Status_HW_CH4	WORD			Status High Word Channel 4
		Status_LW_CH4	WORD			Status Low Word Channel 4
	Operation_Exec	WORD	0		Special Operation Executed word	

Note The table lists all possible variables for the maximum size function block, i.e. the Extended block for the E5_R. For other basic / extended function blocks subsets of variables apply.

B-3 Operate Function Block

The Operate Function Block facilitates the transmission of an OPERATE command to a specific temperature Controller (refer to section 3-3-4 Free Communication Blocks). The table below lists the specifics of this function block.

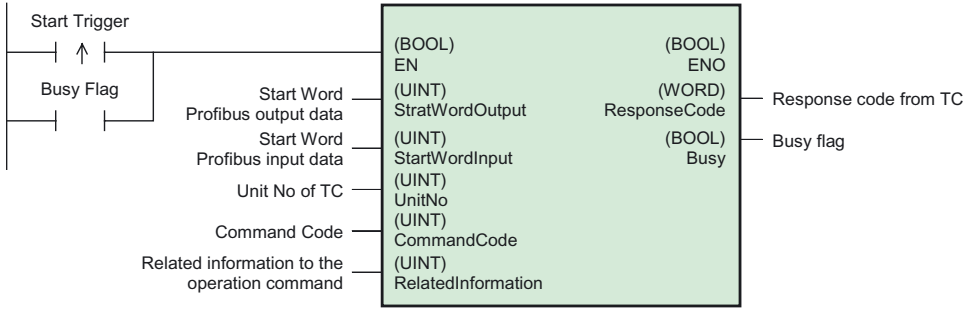
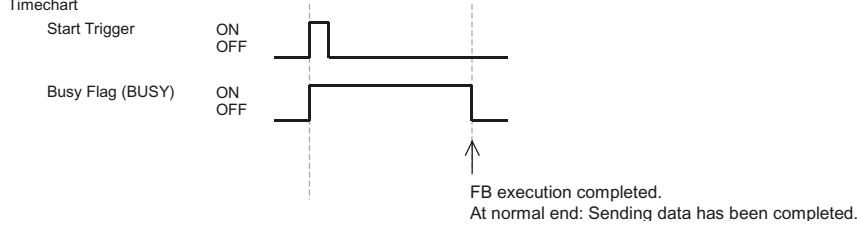
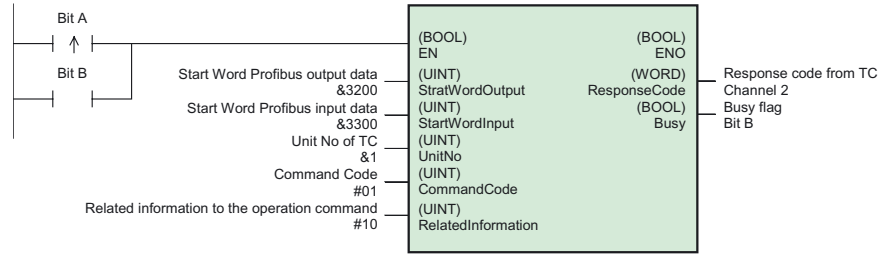
Item	Description
Basic function	Sends an Operation command to a specified Temperature Controller via PROFIBUS.
Symbol	
File name	PRT1_SCU11_Operate.cxf
Function description	Sends an operation command to the CS1/CJ1W-PRM21 PROFIBUS Master I/O addresses allocated to the targeted Temperature Controller, specified by the Unit No. The command is specified by the command code and related information.
Precautions	 <p>Timechart</p> <p>Start Trigger ON OFF</p> <p>Busy Flag (BUSY) ON OFF</p> <p>FB execution completed. At normal end: Sending data has been completed.</p>
EN Input condition	Connect EN to an OR between an upwardly differentiated condition for the start trigger and the BUSY output from the Function Block.
Restrictions on Input variables	<ul style="list-style-type: none"> Always use an upwardly differentiated condition for the EN. If the Input variables are out of range, the ENO flag will turn OFF and the Function Block will not be processed.
Restrictions on Output variables	<ul style="list-style-type: none"> This function block requires multiple cycles to process. Always connect an OR including the BUSY output variable to the EN input variable to ensure that the function block is processed to completion (see Symbol) Do not turn the BUSY output variable ON or OFF outside the function block.
Application example	

The table below lists the Input and Output variables for the Operate function block.

	Name	Variable name	Data type	Default	Range	Description
Input variables	EN	EN	BOOL			1 (ON): Function block started. 0 (OFF): Function block not started.
	Start Word PROFIBUS Output data	StartWordOutput	UINT	3000		Start Word of PROFIBUS Output data in PROFIBUS Master Output data area.
	Start Word PROFIBUS Input data	StartWordInput	UINT	3010		Start Word of PROFIBUS Input data in PROFIBUS Master Input data area.
	Unit No of device	UnitNo	UINT	0	#0 - #63 (0-99)	Unit number of device.
	Command code	CommandCode	UINT	0		Variable type in device.
	Information related to the operation command	RelatedInformation	UINT	0		Specify the Write Start address.
Output variables	ENO	ENO	BOOL			1 (ON): Function block processed normally 0 (OFF): Function block not processed or ended in an error.
	Result of execution of the command	ResponseCode	WORD			Outputs the error code when execution ended in an error in the communications command level. Refer to section 3-3-4 <i>Free Communication Blocks</i> for more information.
	Busy flag	BUSY	BOOL			Automatically turns OFF when processing is completed.

B-4 Read Function Block

The Read Function Block facilitates the transmission of a READ command to a specific temperature Controller (refer to section 3-3-4 *Free Communication Blocks*). The table below lists the specifics of this function block.

Item	Description
Basic function	Reads data from a Temperature Controller's variable area.
Symbol	<p>The diagram shows the symbol for the Read Function Block. It is a rectangular box with a light green background. On the left side, there are seven input lines with labels: 'Start Trigger' (with a Boolean symbol), 'Busy Flag' (with a Boolean symbol), 'Start Word Profibus output data' (with a UINT symbol), 'Start Word Profibus input data' (with a UINT symbol), 'Unit No of TC' (with a UINT symbol), 'Variable Type' (with a UINT symbol), and 'Read Start address from TC' (with a UINT symbol). On the right side, there are four output lines with labels: 'ENO' (with a Boolean symbol), 'ResponseCode' (with a WORD symbol), 'DataRead' (with a DWORD symbol), and 'Busy' (with a Boolean symbol). The text 'Response code from TC' is placed to the right of the ResponseCode output, 'Data read from TC' is to the right of the DataRead output, and 'Busy flag' is to the right of the Busy output.</p>
File name	PRT1_SCU11_Read_Data.cxf
Function description	Sends a Read Data command to the CS1/CJ1W-PRM21 PROFIBUS Master I/O addresses allocated to the targeted Temperature Controller, specified by the Unit No. The data to be read is specified by the Variable Type and the Read Start Address.

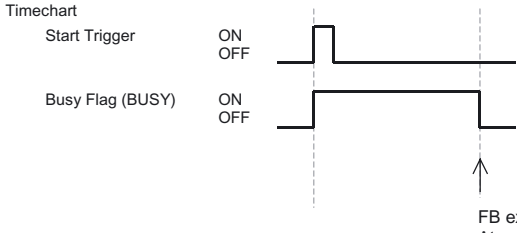
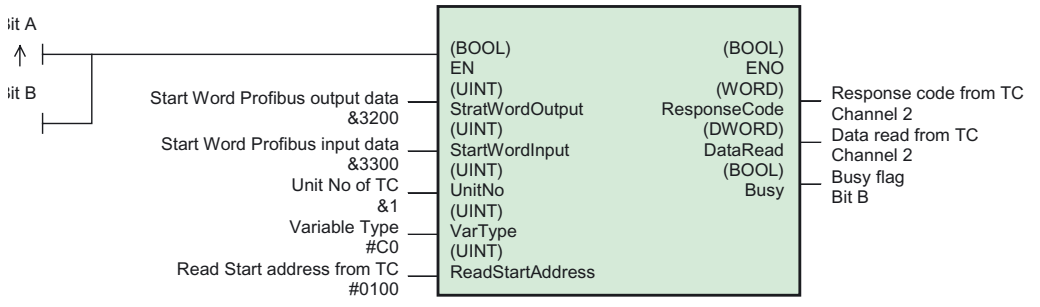
Item	Description
Precautions	<p>Timechart</p> 
EN Input condition	Connect EN to an OR between an upwardly differentiated condition for the start trigger and the BUSY output from the Function Block.
Restrictions on Input variables	<ul style="list-style-type: none"> • Always use an upwardly differentiated condition for the EN. • If the Input variables are out of range, the ENO flag will turn OFF and the Function Block will not be processed.
Restrictions on Output variables	<ul style="list-style-type: none"> • This function block requires multiple cycles to process. Always connect an OR including the BUSY output variable to the EN input variable to ensure that the function block is processed to completion (see Symbol) • Do not turn the BUSY output variable ON or OFF outside the function block.
Application example	

The table below lists the Input and Output variables for the Read function block.

	Name	Variable name	Data type	Default	Range	Description
Input variables	EN	EN	BOOL			1 (ON): Function block started. 0 (OFF): Function block not started.
	Start Word PROFIBUS Output data	StartWordOutput	UINT	3000		Start Word of PROFIBUS Output data in PROFIBUS Master Output data area.
	Start Word PROFIBUS Input data	StartWordInput	UINT	3010		Start Word of PROFIBUS Input data in PROFIBUS Master Input data area.
	Unit No of device	UnitNo	UINT	0	#0 - #63 (0-99)	Unit number of device.
	Variable Type	VarType	UINT	0		Variable type in device.
	Read Start address from device	ReadStartAddress	UINT	0		Specify the Read Start address.

	Name	Variable name	Data type	Default	Range	Description
Output variables	ENO	ENO	BOOL			1 (ON): Function block processed normally. 0 (OFF): Function block not processed or ended in an error.
	Result of execution of the command	ResponseCode	WORD			Outputs the error code when execution ended in an error in the communications command level. Refer to section 3-3-4 <i>Free Communication Blocks</i> for more information.
	Data read from the device	DataRead	DWORD			Data read from the device. (See Note)
	Busy flag	BUSY	BOOL			Automatically turns OFF when processing is completed.

Note The function block ensures that Double Word sized data read from the Temperature Controller is correctly formatted, to match the DWORD data type as defined in the PLC.

B-5 Write Function Block

The Write Function Block facilitates the transmission of a WRITE command to a specific temperature Controller (refer to section 3-3-4 *Free Communication Blocks*). The table below lists the specifics of this function block.

Item	Description
Basic function	Writes data to a Temperature Controller's variable area.
Symbol	
File name	PRT1_SCU11_Write_Data.cxf
Function description	Sends a Write Data command to the CS1/CJ1W-PRM21 PROFIBUS Master I/O addresses allocated to the targeted Temperature Controller, specified by the Unit No. The data to be written and the location to write is to are specified by the DataWrite and the WordStartAddress variables.
Precautions	<p>Timechart</p> <p>FB execution completed. At normal end: Sending data has been completed.</p>
EN Input condition	Connect EN to an OR between an upwardly differentiated condition for the start trigger and the BUSY output from the Function Block.
Restrictions on Input variables	<ul style="list-style-type: none"> Always use an upwardly differentiated condition for the EN. If the Input variables are out of range, the ENO flag will turn OFF and the Function Block will not be processed.

Item	Description
Restrictions on Output variables	<ul style="list-style-type: none"> This function block requires multiple cycles to process. Always connect an OR including the BUSY output variable to the EN input variable to ensure that the function block is processed to completion (see Symbol) Do not turn the BUSY output variable ON or OFF outside the function block.
Application example	<p>Response data is copied to channel 2 after Busy flag is OFF.</p>

The table below lists the Input and Output variables for the Write function block.

	Name	Variable name	Data type	Default	Range	Description
Input variables	EN	EN	BOOL			1 (ON): Function block started. 0 (OFF): Function block not started.
	Start Word PROFIBUS Output data	StartWordOutput	UINT	3000		Start Word of PROFIBUS Output data in PROFIBUS Master Output data area.
	Start Word PROFIBUS Input data	StartWordInput	UINT	3010		Start Word of PROFIBUS Input data in PROFIBUS Master Input data area.
	Unit No of device	UnitNo	UINT	0	#0 - #63 (0-99)	Unit number of device.
	Variable Type	VarType	UINT	0		Variable type in device.
	Write Start address from device	WriteStartAddress	UINT	0		Start address of variable to which the data must be written.
	Data to be written	DataWrite	DWORD	0		Specify the data to be written.
Output variables	ENO	ENO	BOOL			1 (ON): Function block processed normally 0 (OFF): Function block not processed or ended in an error.
	Result of execution of the command	ResponseCode	WORD			Outputs the error code when execution ended in an error in the communications command level. Refer to section 3-3-4 <i>Free Communication Blocks</i> for more information.
	Busy flag	BUSY	BOOL			Automatically turns OFF when processing is completed.

Note The function block ensures that Double Word sized data written to the Temperature Controller is correctly formatted.

Index

Numbers

110 mH Inductor, 33
220 ohm resistor, 33
2-wire, 24
3-3-1 Using CX-Thermo, 54
4-wire, 24, 27

A

About
 Manual, ix
A-line, 21
Auto-CLEAR, 6
Auxiliary RS-323 interface, 54

B

Basic Operating Procedure, 14
Baud rate, 12, 20, 22, 32, 54
BF, 19, 54, 58, 59
B-line, 21
Broadcast, 5, 47
Bus Access Protocol, 2
Bus fail, 19
Bus Termination, 33
Bus termination, 33

C

Cable, 32, 34
Cable Length, 32
Cable length, 3
Cable shield connection, 34
Channel numbers, 43
Chk_Cfg, 19
Class 1, 4
Class 1 Master, 4
Class 2, 4
Class 2 Master, 4
Cleaning, 60
CLEAR, 5, 6
COMM, 19, 54, 58, 59
Command code, 43
Command word, 42
Common parameters, 38
Communication
 Broadcast, 5

 Multicast, 5
 Multi-peer, 5
Communication fails, 44, 48
Communication format, 22
Communication Medium, 31
Compoway-F, 9
Configuration, 6, 35
Connector, 12, 21, 34
 Bus cable connector, 34
 DGND, 22
 RTS, 21
 VP, 22
CX-Profibus, 35, 36, 40, 44, 49
CX-Thermo, 54, 55

D

Data length, 55
Data_Exchange, 19
Declaration of Conformity, xv
Device profile, 4
Diagnostic, 5, 13
Digital Panel Meter, 25
Dimensions, 13
DIN-rail, 23
DIP-switch, 20
DIP-switches, 18
Download configuration, 35
DTM Configuration, 36

E

E5AK/E5EK
 Connection, 28
 Wiring, 28
 RS-422, 28
E5AR, 8, 26
E5ER, 26
E5ZN, 8, 25
Electro-magnetic compatibility, 34
EMC directive, xv
EN50170, 2, 21
Environment, 11
ERR, 19, 58
Error code, 43
Extensive Diagnostics, 5
External Dimensions, 13

F

- F7 Inverter
 - Connection, 29
 - Wiring, 29
 - RS-422, 29
 - RS-485, 30
- Fail-safe, 6
- FCOM, 19, 54, 58, 59
- FDT/DTM
 - FDT Container application, 7
 - FDT/DTM Concept, 7
- FERR, 19, 54, 58, 59
- Fixed communication block, 40, 41, 48, 51
- Fixed communication blocks, 40
- Flexible communication blocks, 40
- Free communication block, 40
- Free Communication Blocks, 9
- Free communication blocks, 40, 44
- Front case, 11

G-H

- Galvanically isolated, 54
- Gateway
 - Compoway-F, 9
 - Configuration, 10
 - Free Communication Blocks, 9
 - I/O Data, 9
 - setup, 8
 - Special operations, 9
 - Troubleshooting, 10
 - unit, 8
- Generic slave DTM
 - Configuring, 35
 - I/O Configuration
 - Appending, 36
 - Inserting, 36
- Ground, 34
- GSD File
 - DTM, 8
- GSD file, 7, 36
 - DP-master, 7
 - DP-slave, 7
 - General Section, 7
 - Language, 7
- GSD File Language, 7
- GSD-file, 7, 35
- Host Link, 9, 10, 50

I

- I/O configuration, 36

- I/O Data, 9
- I/O data, 11, 13
- I/O module, 35
- IEC 1158-2, 2
- Inductor, 33
- Inspection, 60
- Inspection Equipment, 60
- Inspection Procedure, 60
- Installation, 11, 14
- ISO-7498, 2

K

- K3GN Digital Panel Meter, 25
- K-Format
 - Fixed Communication blocks, 48
 - Free Communication blocks, 49
 - Operation Execute, 48
 - Parameters, 48
 - Wiring
 - RS-422A, 28
 - RS-485, 28

L-M

- LED, 18, 58
 - BF, 19, 54, 58, 59
 - COMM, 19, 54, 58, 59
 - ERR, 19, 58
 - FCOM, 19, 54, 58, 59
 - FERR, 19, 54, 58, 59
 - RUN, 19, 58
- LED Indicators
 - Specifications, 19
- LED indicators, 18, 58
- Low voltage directive, xv
- MAC, 4
- Maintenance, 60
 - Cleaning, 60
 - Inspection, 60
- Manual
 - About, ix
 - Revision history, 79
- Master, 4
- Master Devices, 4
- Maximum amount of data, 40
- Maximum number of devices, 40
- Maximum number of modules, 40
- MCW151, 8, 9, 27
- Memobus
 - Fixed Communication blocks, 51
 - Flexible Communication blocks, 51

- Parameters, 52
- Wiring
 - RS-422A, 29
 - RS-485, 30
- Module parameters, 38
- Monitoring
 - Interval, 5
 - Master, 5
 - Slave, 6
- Mounting, 23
- Mounting Procedure, 23
- MRC/SRC, 45
- Multicast, 5
- Multi-peer, 5

N

- Network operation modes
 - Auto-CLEAR, 6
 - CLEAR, 6
 - Fail-safe State, 6
 - OFF-LINE, 6
 - OPERATE, 6
 - STOP, 6
- Network structure, 31
 - Linear bus topology, 31
 - Repeater, 31
 - Tree topology, 31
- Node address, 19, 30
- Noise, 23
- Not_Ready, 54

O-P

- OFF-LINE, 6
- OMRON
 - Copyright notice, vi
- OPERATE, 6
- Operation, 45
- Operation mini FINS command, 45
- OSI
 - ISO-7498, 2
 - Layer 1, 2, 3
 - Layer 2, 2, 4
 - Layer 3, 3
 - Layer 7, 2
 - Medium Access Control, 4
 - OSI Layer 1, 2 and User Interface, 3
 - Polling Procedure, 4
 - Token Passing, 4
- OSI reference model, 2
- Parameters, 38
 - Common, 38

- Module, 38
- Parity, 55
- Pheripheral setting, 21
- Polling Procedure, 4
- Precautions, 23
 - Application, xiii
 - General, xii
 - Operating Environment, xiii
 - Safety, xii
- PROFIBUS, 2
 - Diagnostics, 53
- PROFIBUS-DP, 2
- PROFIBUS-FMS, 2
- PROFIBUS-PA, 2

R

- R88A-MCW151-E, 8, 9, 27
- Read, 45
- Read mini FINS command, 45
- Receiver line, 22
- Repeater, 3
- Replacement, 61
- Response word, 42
- Rotary switch, 19
- RS-232C, 9, 12, 18, 54
- RS-422, 9, 22
- RS-422A, 27
- RS-485, 3, 9, 22, 24, 25, 31
 - Cable Type, 32
- RUN, 19, 58

S

- Safety Precautions, xii
- Sending Free Communication, 47
- Services, 13
- Set_Prm, 19
- Shielding, 34
- shock resistance, 11
- Slave, 4
- Slave Devices, 4
- Special Operation, 42
- Special operations, 9, 41
- Specifications, 10
- Status word, 50
- STOP, 6
- Stop bit, 55
- Stub Lines, 33

T

Temperature Controller, 26
Temperature Controllers, 24
Termination resistor, 12
Termination Resistor, 33
Token Passing, 4
Trademarks, vi
Transmission Speed, 3
Transmission speed, 3
Troubleshooting, 10

U

Unit replacement, 61
 Precautions, 61
Using CX-Thermo, 54

V-W

vibration resistance, 11
Watchdog, 37
Wire A, 34
Wire B, 34
Wiring, 34
Write, 45, 46
Write mini FINS command, 46

Revision History

A manual revision code appears as a suffix to the catalog number on the front cover of the manual.

Cat. No. W01E-EN-01

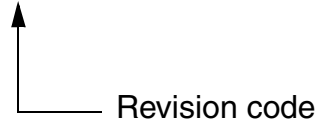

The following table outlines the changes made to the manual during each revision. The page numbers of a revision refer to the previous version.

Revision Code	Date	Revised Content
01	November 22, 2004	Initial version.
02	September 19, 2005	<p>Changed manual title.</p> <p>Corrected PROFIBUS DP naming to comply with PROFIBUS standards.</p> <p>Changed unit name reference to Host Link / Compoway-F to RS-422A/RS-485.</p> <p>Changed unit naming to more consistent name.</p> <p>Page ix: Added Unit version table.</p> <p>Page ix: Added E5_K and F7 Inverter manuals to table.</p> <p>Page 6: Removed bullets from list.</p> <p>Page 9: Added E5AK/E5EK and F7 Inverter to table.</p> <p>Page 9: Added text below table on Auxiliary port connection to other protocols.</p> <p>Page 9: Added note on multiple protocol use.</p> <p>Page 9: Added a branches for Memobus and K-Format protocol to image.</p> <p>Page 9: Added description for Memobus and K-Format protocols.</p> <p>Page 10: Removed sentence on Special Operation.</p> <p>Page 10: Added paragraph on Fixed Communication blocks.</p> <p>Page 10: Added descriptions on Memobus and K-Format protocol.</p> <p>Page 11: Added text and version table to Specifications section.</p> <p>Page 11: Changed 'modules' to 'units'</p> <p>Page 11: Changed I/O words to bytes.</p> <p>Page 12: Reformatted specification table, added new protocols.</p> <p>Page 14: Improved flow chart.</p> <p>Page 19: Reformatted table.</p> <p>Page 19: Improved text of section 2-1-3.</p> <p>Page 20: Added paragraph on dip-switch 3.</p> <p>Page 20: Reformatted information on switches in to tables and notes.</p> <p>Page 21: Changed title of section 2-1-5.</p> <p>Page 21: Reformatted table on switches, to include switch dependencies.</p> <p>Page 21: Added Note to RS-422A/RS-485 table.</p> <p>Page 22: Renamed sections 2-2 and 2-2-2.</p> <p>Page 22: Reformatted communication formats in to table.</p> <p>Page 23: Added note on baud rates to end of section 2-3-3.</p> <p>Page 24: Added note on baud rates to end of section 2-3-4.</p> <p>Page 25: Renamed E5ZN terminals in figure.</p> <p>Page 25: Added note on baud rates to end of section 2-3-5.</p> <p>Page 26: Added section 2-3-7 and 2-3-8.</p> <p>Page 32: Added reference to CS1/CJ1 PROFIBUS Master manual.</p> <p>Page 32: Improved text of section 2-6-1.</p> <p>Page 35: Removed Note after example.</p>

Revision Code	Date	Revised Content
02	September 19, 2005	Page 38: Added paragraph on Flexible communication blocks. Page 38: Reformatted paragraph on PROFIBUS I/O size. Page 40: Improved text and figures of section 3-3-2. Page 41: Inserted new section 3-3-1. Page 42: Improved text, reformatted table. Page 43: Improved text on mini-FINS commands. Page 44: Changed section 3-3-4 to 3-8, inserted new section 3-4. Page 47: Inserted new sections 3-6 and 3-7. Page 50, Renamed section 4.2.2. Page 55: Added Appendices A2 and A3. Removed Abbreviations section.