

# MicroHAWK V330-F

## Multicode Reader

### Compact Ethernet barcode reader.

- Simple configuration with WebLink.
- 5 megapixel sensor available.
- Smallest in class.
- IP40.
- Single snap-in RJ45 connector and cable.
- Ethernet TCP/IP, EtherNet/IP, and PROFINET.



### MicroHAWK V330-F

#### Optics Options

Appearance	Type	Part Number
	Diffuser Kit – Peel and Stick Accessory. Exterior to unit.	V330-AF1
	Polarizer Kit – Peel and Stick Accessory. Exterior to unit.	V330-AF2

#### Direct Wiring Options

Appearance	Type	Length	Part Number
	Standard Ethernet Cables, In-Cabinet Use; Standard RJ45 Connectors on Both Ends; Green	1 Meter	XS6W-5PUR8SS100CM-G
		3 Meters	XS6W-5PUR8SS300CM-G
		5 Meters	XS6W-5PUR8SS500CM-G
		10 Meters	XS6W-5PUR8SS1000CM-G
		15 Meters	XS6W-5PUR8SS1500CM-G
	Standard Ethernet Cables, Out-of-Cabinet Use; Rugged RJ45 Connectors on Both Ends; Light Blue	1 Meter	XS5W-T421-CMD-K
		3 Meters	XS5W-T421-EMD-K
		5 Meters	XS5W-T421-GMD-K
		10 Meters	XS5W-T421-JMD-K
		15 Meters	XS5W-T421-KMD-K
	High Flex Ethernet Cables for Robot and Cable Tray Use; Rugged RJ45 Connectors on Both Ends; Light Blue	1 Meter	XS5W-T421-CMD-KR
		3 Meters	XS5W-T421-EMD-KR
		5 Meters	XS5W-T421-GMD-KR
		10 Meters	XS5W-T421-JMD-KR
		15 Meters	XS5W-T421-KMD-KR

# V330-F

## V330-F Part Number Structure

Use this legend when defining product part numbers. Please note that not all combinations of parameters are valid. For instance, fixed focus distance of 50 mm is not available with Narrow Lens. When ordering, use valid part numbers from the tables in the Ordering Information section only.

### V330-F[XXX][Y][ZZZ]-NN[P]

Key	Classification	Code	Meaning
XXX	Focus Distance (mm)	050	Fixed Focus at 50 mm
		064	Fixed Focus at 64 mm
		081	Fixed Focus at 81 mm
		102	Fixed Focus at 102 mm
		133	Fixed Focus at 133 mm
		190	Fixed Focus at 190 mm
		300	Fixed Focus at 300 mm
Y	Lens	W	Wide Field of View - 5.2 mm Focal Length Lens
		M	Medium Field of View – 7.7 mm Focal Length Lens
		N	Narrow Field of View – 16 mm Focal Length Lens
ZZZ	Sensor	03M	752 x 480 (0.3 MP) Pixel, Mono Sensor, Global Shutter
		12M	1280 x 960 (1.2 MP) Pixel, Mono Sensor, Global Shutter
		50C	2592 x 1944 (5 MP) Pixel, Color Sensor, Rolling Shutter
L	Light Type	N	No Outer Light
C	Light Color	N	No Outer Light
P	Software License	P	High Speed, Plus Mode
		X	High Speed, X-Mode

#### Example Part Number:

- V330-F064N50C-NNX: Fixed Focus at 64 mm, Narrow Lens, 5 MP Color – No Light, High Speed, X-Mode

### V330-F Valid Product Matrix

Model	Category	Focus Type	Sensor	Lens	Focus Distance (mm)	Light	License
V330-F	Monochrome	Fixed Focus	03M, 12M	W, M	50, 64, 81, 102, 133, 190, 300	None	P, X
	Color	Fixed Focus	50C	W, M	50, 64, 81, 102, 133, 190, 300	None	P, X
	Monochrome	Fixed Focus	03M, 12M	N	64, 81, 102, 133, 190, 300	None	P, X
	Color	Fixed Focus	50C	N	64, 81, 102, 133, 190, 300	None	P, X

## V330-F Ordering Information

### Categories:

#### 1. Fixed Focus Cameras

- a) V330-F Monochrome and Color Fixed Focus Camera with Standard Lens
- b) V330-F Monochrome and Color Fixed Focus Camera with Narrow Lens

#### 1a) V330-F Mono and Color Camera with Standard Lens: Valid Combinations

##### V330-F[XXX][Y][ZZZ]-NN[P]

Key	Classification	Code	Meaning
XXX	Focus Distance (mm)	050	Fixed Focus at 50 mm
		064	Fixed Focus at 64 mm
		081	Fixed Focus at 81 mm
		102	Fixed Focus at 102 mm
		133	Fixed Focus at 133 mm
		190	Fixed Focus at 190 mm
		300	Fixed Focus at 300 mm
Y	Lens	W	Wide Field of View - 5.2 mm Focal Length Lens
		M	Medium Field of View – 7.7 mm Focal Length Lens
ZZZ	Sensor	03M	752 x 480 (0.3 MP) Pixel, Mono Sensor, Global Shutter
		12M	1280 x 960 (1.2 MP) Pixel, Mono Sensor, Global Shutter
		50C	2592 x 1944 (5 MP) Pixel, Color Sensor, Rolling Shutter
P	Software License	P	High Speed, Plus Mode
		X	High Speed, X-Mode

#### 1b) V330-F Mono and Color Camera with Narrow Lens: Valid Combinations

**Note:** 50 mm Fixed Focus option not available with Narrow Lens.

##### V330-F[XXX]N[ZZZ]-NN[P]

Key	Classification	Code	Meaning
XXX	Focus Distance (mm)	064	Fixed Focus at 64 mm
		081	Fixed Focus at 81 mm
		102	Fixed Focus at 102 mm
		133	Fixed Focus at 133 mm
		190	Fixed Focus at 190 mm
		300	Fixed Focus at 300 mm
ZZZ	Sensor	03M	752 x 480 (0.3 MP) Pixel, Mono Sensor, Global Shutter
		12M	1280 x 960 (1.2 MP) Pixel, Mono Sensor, Global Shutter
		50C	2592 x 1944 (5 MP) Pixel, Color Sensor, Rolling Shutter
P	Software License	P	High Speed, Plus Mode
		X	High Speed, X-Mode

# V330-F

## Field of View Charts

Specifications are subject to change.

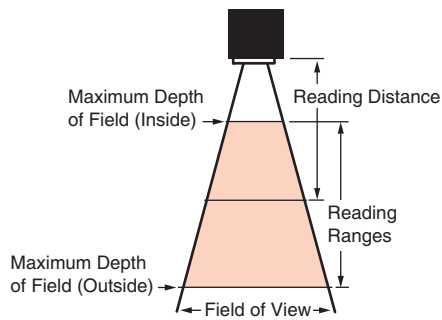

### Fixed Focus Field of View (mm) - Wide Lens

Distance (mm)	0.3 MP		1.2 MP		5 MP	
	Width	Height	Width	Height	Width	Height
50	49	32	53	39	50	38
64	62	39	66	49	63	47
81	76	49	81	61	78	58
102	95	60	101	75	96	72
133	121	78	129	97	124	92
190	171	109	182	136	174	130
300	266	170	283	213	271	202

### Fixed Focus Field of View (mm) - Medium Lens

Distance (mm)	0.3 MP		1.2 MP		5 MP	
	Width	Height	Width	Height	Width	Height
50	34	22	36	27	35	26
64	43	27	45	34	43	32
81	53	34	56	42	54	40
102	66	42	70	52	67	50
133	84	54	90	67	86	64
190	119	76	126	95	121	90
300	185	118	196	147	188	140

### Fixed Focus Field of View (mm) - Narrow Lens

Distance (mm)	1.2 MP	
	Width	Height
64	21	15
400	118	88

## Readability Tables

---

The readability tables on the following pages are designed to help users choose the best read-distance, sensor, and lens combination to read their particular code size and code type successfully.

The readability tables show the calculated PPE (pixels per element) for a range of typical code sizes at all the MicroHAWK Fixed Focus distances with the Wide, Medium, and Narrow lens as well as with the 0.3MP, 1.2MP, and 5MP sensors.

PPE is defined as the following for 1D and 2D codes:

- PPE for 1D codes is the number of pixels across the thinnest bar in the barcode.
- PPE for 2D codes is the number of pixels across a single code cell.

The tables show a color code for readability based on Direct Part Marks (DPM) where red means not likely to read, and green means that it should read. The tables also show a range of colors between red and green, while showing the zone where read rates may be acceptable for high-contrast, well-printed labels and can be considered. See the 1D and 2D Code Readability Guidelines below for Minimum and Preferred PPE for both DPM marks and high-contrast labels.



### 1D Code Readability Guidelines

---

#### High-Contrast Labels

- 1.5 pixels per thin bar is suggested minimum;
- 2 pixels or more per thin bar is preferred.

#### Direct Part Marks

- 2 pixels per thin bar is suggested minimum;
- 2.5 pixels or more per thin bar is preferred.

### 2D Code Readability Guidelines

---

#### High-Contrast Labels

- 2.5 – 2.75 pixels per 2D cell is suggested minimum;
- 3.5 – 5 pixels per 2D cell is preferred.

#### Direct Part Marks

- 3.25 pixels per 2D Cell is suggested minimum;
- 4 – 6 pixels per 2D Cell is preferred.

# Readability Table – 0.3 Megapixel

= Maximum Readability  
 = Minimum Readability

0.3 Megapixel – Pixels Per Element / Readability Chart																	
Minimum Element Size	Readability of 1D Code at Distance (mm)								Lens	Readability of 2D Code at Distance (mm)							
	50	64	81	102	133	190	300	400		50	64	81	102	133	190	300	400
2 mil	0.7	0.6	0.5	0.4	0.3	0.2	0.1	0.1	Wide Lens	0.7	0.6	0.5	0.4	0.3	0.2	0.1	0.1
2.5 mil	0.9	0.7	0.6	0.5	0.4	0.3	0.2	0.1		0.9	0.7	0.6	0.5	0.4	0.3	0.2	0.1
3.3 mil	1.2	1.0	0.8	0.6	0.5	0.4	0.2	0.2		1.2	1.0	0.8	0.6	0.5	0.4	0.2	0.2
5 mil	1.9	1.5	1.2	1.0	0.8	0.5	0.3	0.3		1.9	1.5	1.2	1.0	0.8	0.5	0.3	0.3
7.5 mil	2.8	2.2	1.8	1.5	1.1	0.8	0.5	0.4		2.8	2.2	1.8	1.5	1.1	0.8	0.5	0.4
10 mil	3.7	3.0	2.4	1.9	1.5	1.1	0.7	0.5		3.7	3.0	2.4	1.9	1.5	1.1	0.7	0.5
15 mil	5.6	4.5	3.6	2.9	2.3	1.6	1.0	0.8		5.6	4.5	3.6	2.9	2.3	1.6	1.0	0.8
20 mil	7.4	6.0	4.8	3.9	3.0	2.1	1.4	1.0		7.4	6.0	4.8	3.9	3.0	2.1	1.4	1.0
30 mil	11.1	8.9	7.2	5.8	4.5	3.2	2.1	1.6		11.1	8.9	7.2	5.8	4.5	3.2	2.1	1.6
40 mil	14.9	11.9	9.6	7.8	6.0	4.3	2.8	2.1		14.9	11.9	9.6	7.8	6.0	4.3	2.8	2.1
2 mil	1.2	1.0	0.8	0.6	0.5	0.3	0.2	0.2	Medium Lens	1.2	1.0	0.8	0.6	0.5	0.3	0.2	0.2
2.5 mil	1.5	1.2	1.0	0.8	0.6	0.4	0.3	0.2		1.5	1.2	1.0	0.8	0.6	0.4	0.3	0.2
3.3 mil	2.0	1.6	1.3	1.0	0.8	0.6	0.4	0.3		2.0	1.6	1.3	1.0	0.8	0.6	0.4	0.3
5 mil	3.0	2.4	1.9	1.6	1.2	0.9	0.6	0.4		3.0	2.4	1.9	1.6	1.2	0.9	0.6	0.4
7.5 mil	4.5	3.6	2.9	2.3	1.8	1.3	0.8	0.6		4.5	3.6	2.9	2.3	1.8	1.3	0.8	0.6
10 mil	5.9	4.8	3.8	3.1	2.4	1.7	1.1	0.8		5.9	4.8	3.8	3.1	2.4	1.7	1.1	0.8
15 mil	8.9	7.2	5.8	4.7	3.6	2.6	1.7	1.2		8.9	7.2	5.8	4.7	3.6	2.6	1.7	1.2
20 mil	11.9	9.5	7.7	6.2	4.8	3.4	2.2	1.7		11.9	9.5	7.7	6.2	4.8	3.4	2.2	1.7
30 mil	17.8	14.3	11.5	9.3	7.3	5.2	3.3	2.5		17.8	14.3	11.5	9.3	7.3	5.2	3.3	2.5
40 mil	23.8	19.1	15.4	12.4	9.7	6.9	4.4	3.3		23.8	19.1	15.4	12.4	9.7	6.9	4.4	3.3
2 mil	2.5	2.0	1.6	1.3	1.0	0.7	0.5	0.3	Narrow Lens	2.5	2.0	1.6	1.3	1.0	0.7	0.5	0.3
2.5 mil	3.1	2.5	2.0	1.6	1.3	0.9	0.6	0.4		3.1	2.5	2.0	1.6	1.3	0.9	0.6	0.4
3.3 mil	4.1	3.3	2.6	2.1	1.7	1.2	0.8	0.6		4.1	3.3	2.6	2.1	1.7	1.2	0.8	0.6
5 mil	6.2	4.9	4.0	3.2	2.5	1.8	1.1	0.9		6.2	4.9	4.0	3.2	2.5	1.8	1.1	0.9
7.5 mil	9.2	7.4	6.0	4.8	3.8	2.7	1.7	1.3		9.2	7.4	6.0	4.8	3.8	2.7	1.7	1.3
10 mil	12.3	9.9	8.0	6.4	5.0	3.6	2.3	1.7		12.3	9.9	8.0	6.4	5.0	3.6	2.3	1.7
15 mil	18.5	14.8	12.0	9.7	7.5	5.4	3.4	2.6		18.5	14.8	12.0	9.7	7.5	5.4	3.4	2.6
20 mil	24.7	19.8	16.0	12.9	10.0	7.1	4.6	3.5		24.7	19.8	16.0	12.9	10.0	7.1	4.6	3.5
30 mil	37.0	29.7	24.0	19.3	15.1	10.7	6.9	5.2		37.0	29.7	24.0	19.3	15.1	10.7	6.9	5.2
40 mil	49.3	39.6	31.9	25.8	20.1	14.3	9.2	6.9		49.3	39.6	31.9	25.8	20.1	14.3	9.2	6.9

# Readability Table – 1.2 Megapixel

1.2 Megapixel – Pixels Per Element / Readability Chart																				
Minimum Element Size	Readability of 1D Code at Distance (mm)								Lens	Readability of 2D Code at Distance (mm)										
	50	64	81	102	133	190	300	400		50	64	81	102	133	190	300	400			
Wide Lens	2 mil	1.2	1.0	0.8	0.6	0.5	0.4	0.2	0.2	Wide Lens	1.2	1.0	0.8	0.6	0.5	0.4	0.2	0.2		
	2.5 mil	1.5	1.2	1.0	0.8	0.6	0.4	0.3	0.2		1.5	1.2	1.0	0.8	0.6	0.4	0.3	0.2		
	3.3 mil	2.0	1.6	1.3	1.1	0.8	0.6	0.4	0.3		2.0	1.6	1.3	1.1	0.8	0.6	0.4	0.3		
	5 mil	3.1	2.5	2.0	1.6	1.3	0.9	0.6	0.4		3.1	2.5	2.0	1.6	1.3	0.9	0.6	0.4		
	7.5 mil	4.6	3.7	3.0	2.4	1.9	1.3	0.9	0.6		4.6	3.7	3.0	2.4	1.9	1.3	0.9	0.6		
	10 mil	6.2	5.0	4.0	3.2	2.5	1.8	1.1	0.9		6.2	5.0	4.0	3.2	2.5	1.8	1.1	0.9		
	15 mil	9.3	7.4	6.0	4.8	3.8	2.7	1.7	1.3		9.3	7.4	6.0	4.8	3.8	2.7	1.7	1.3		
	20 mil	12.4	9.9	8.0	6.5	5.0	3.6	2.3	1.7		12.4	9.9	8.0	6.5	5.0	3.6	2.3	1.7		
	30 mil	18.5	14.9	12.0	9.7	7.5	5.4	3.4	2.6		18.5	14.9	12.0	9.7	7.5	5.4	3.4	2.6		
	40 mil	24.7	19.8	16.0	12.9	10.1	7.2	4.6	3.5		24.7	19.8	16.0	12.9	10.1	7.2	4.6	3.5		
	Medium Lens	2 mil	1.8	1.4	1.2	0.9	0.7	0.5	0.3		0.2	Medium Lens	1.8	1.4	1.2	0.9	0.7	0.5	0.3	0.2
		2.5 mil	2.2	1.8	1.4	1.2	0.9	0.6	0.4		0.3		2.2	1.8	1.4	1.2	0.9	0.6	0.4	0.3
3.3 mil		2.9	2.4	1.9	1.5	1.2	0.9	0.5	0.4	2.9	2.4		1.9	1.5	1.2	0.9	0.5	0.4		
5 mil		4.5	3.6	2.9	2.3	1.8	1.3	0.8	0.6	4.5	3.6		2.9	2.3	1.8	1.3	0.8	0.6		
7.5 mil		6.7	5.4	4.3	3.5	2.7	1.9	1.2	0.9	6.7	5.4		4.3	3.5	2.7	1.9	1.2	0.9		
10 mil		8.9	7.2	5.8	4.7	3.6	2.6	1.7	1.2	8.9	7.2		5.8	4.7	3.6	2.6	1.7	1.2		
15 mil		13.4	10.7	8.7	7.0	5.4	3.9	2.5	1.9	13.4	10.7		8.7	7.0	5.4	3.9	2.5	1.9		
20 mil		17.8	14.3	11.5	9.3	7.3	5.2	3.3	2.5	17.8	14.3		11.5	9.3	7.3	5.2	3.3	2.5		
30 mil		26.7	21.5	17.3	14.0	10.9	7.7	5.0	3.7	26.7	21.5		17.3	14.0	10.9	7.7	5.0	3.7		
40 mil		35.6	28.6	23.1	18.6	14.5	10.3	6.6	5.0	35.6	28.6		23.1	18.6	14.5	10.3	6.6	5.0		
Narrow Lens	2 mil	3.9	3.2	2.6	2.1	1.6	1.1	0.7	0.6	Narrow Lens	3.9	3.2	2.6	2.1	1.6	1.1	0.7	0.6		
	2.5 mil	4.9	4.0	3.2	2.6	2.0	1.4	0.9	0.7		4.9	4.0	3.2	2.6	2.0	1.4	0.9	0.7		
	3.3 mil	6.5	5.2	4.2	3.4	2.7	1.9	1.2	0.9		6.5	5.2	4.2	3.4	2.7	1.9	1.2	0.9		
	5 mil	9.9	7.9	6.4	5.2	4.0	2.9	1.8	1.4		9.9	7.9	6.4	5.2	4.0	2.9	1.8	1.4		
	7.5 mil	14.8	11.9	9.6	7.7	6.0	4.3	2.7	2.1		14.8	11.9	9.6	7.7	6.0	4.3	2.7	2.1		
	10 mil	19.7	15.8	12.8	10.3	8.0	5.7	3.7	2.8		19.7	15.8	12.8	10.3	8.0	5.7	3.7	2.8		
	15 mil	29.6	23.8	19.2	15.5	12.0	8.6	5.5	4.1		29.6	23.8	19.2	15.5	12.0	8.6	5.5	4.1		
	20 mil	39.5	31.7	25.6	20.6	16.1	11.4	7.3	5.5		39.5	31.7	25.6	20.6	16.1	11.4	7.3	5.5		
	30 mil	59.2	47.5	38.3	30.9	24.1	17.1	11.0	8.3		59.2	47.5	38.3	30.9	24.1	17.1	11.0	8.3		
	40 mil	78.9	63.3	51.1	41.3	32.1	22.8	14.6	11.1		78.9	63.3	51.1	41.3	32.1	22.8	14.6	11.1		

# Readability Table – 5 Megapixel

5 Megapixel – Pixels Per Element / Readability Chart																	
Minimum Element Size	Readability of 1D Code at Distance (mm)								Lens	Readability of 2D Code at Distance (mm)							
	50	64	81	102	133	190	300	400		50	64	81	102	133	190	300	400
2 mil	1.7	1.4	1.1	0.9	0.7	0.5	0.3	0.2	Wide Lens	1.7	1.4	1.1	0.9	0.7	0.5	0.3	0.2
2.5 mil	2.2	1.7	1.4	1.1	0.9	0.6	0.4	0.3		2.2	1.7	1.4	1.1	0.9	0.6	0.4	0.3
3.3 mil	2.8	2.3	1.8	1.5	1.2	0.8	0.5	0.4		2.8	2.3	1.8	1.5	1.2	0.8	0.5	0.4
5 mil	4.3	3.5	2.8	2.3	1.8	1.2	0.8	0.6		4.3	3.5	2.8	2.3	1.8	1.2	0.8	0.6
7.5 mil	6.5	5.2	4.2	3.4	2.6	1.9	1.2	0.9		6.5	5.2	4.2	3.4	2.6	1.9	1.2	0.9
10 mil	8.6	6.9	5.6	4.5	3.5	2.5	1.6	1.2		8.6	6.9	5.6	4.5	3.5	2.5	1.6	1.2
15 mil	12.9	10.4	8.4	6.8	5.3	3.7	2.4	1.8		12.9	10.4	8.4	6.8	5.3	3.7	2.4	1.8
20 mil	17.3	13.9	11.2	9.0	7.0	5.0	3.2	2.4		17.3	13.9	11.2	9.0	7.0	5.0	3.2	2.4
30 mil	25.9	20.8	16.8	13.5	10.5	7.5	4.8	3.6		25.9	20.8	16.8	13.5	10.5	7.5	4.8	3.6
40 mil	34.5	27.7	22.4	18.1	14.1	10.0	6.4	4.8		34.5	27.7	22.4	18.1	14.1	10.0	6.4	4.8
2 mil	2.5	2.0	1.6	1.3	1.0	0.7	0.5	0.3	Medium Lens	2.5	2.0	1.6	1.3	1.0	0.7	0.5	0.3
2.5 mil	3.1	2.5	2.0	1.6	1.3	0.9	0.6	0.4		3.1	2.5	2.0	1.6	1.3	0.9	0.6	0.4
3.3 mil	4.1	3.3	2.7	2.1	1.7	1.2	0.8	0.6		4.1	3.3	2.7	2.1	1.7	1.2	0.8	0.6
5 mil	6.2	5.0	4.0	3.3	2.5	1.8	1.2	0.9		6.2	5.0	4.0	3.3	2.5	1.8	1.2	0.9
7.5 mil	9.3	7.5	6.0	4.9	3.8	2.7	1.7	1.3		9.3	7.5	6.0	4.9	3.8	2.7	1.7	1.3
10 mil	12.5	10.0	8.1	6.5	5.1	3.6	2.3	1.7		12.5	10.0	8.1	6.5	5.1	3.6	2.3	1.7
15 mil	18.7	15.0	12.1	9.8	7.6	5.4	3.5	2.6		18.7	15.0	12.1	9.8	7.6	5.4	3.5	2.6
20 mil	24.9	20.0	16.1	13.0	10.1	7.2	4.6	3.5		24.9	20.0	16.1	13.0	10.1	7.2	4.6	3.5
30 mil	37.4	30.0	24.2	19.5	15.2	10.8	6.9	5.2		37.4	30.0	24.2	19.5	15.2	10.8	6.9	5.2
40 mil	49.8	40.0	32.3	26.0	20.3	14.4	9.2	7.0		49.8	40.0	32.3	26.0	20.3	14.4	9.2	7.0
2 mil	5.5	4.4	3.6	2.9	2.2	1.6	1.0	0.8	Narrow Lens	5.5	4.4	3.6	2.9	2.2	1.6	1.0	0.8
2.5 mil	6.9	5.5	4.5	3.6	2.8	2.0	1.3	1.0		6.9	5.5	4.5	3.6	2.8	2.0	1.3	1.0
3.3 mil	9.1	7.3	5.9	4.8	3.7	2.6	1.7	1.3		9.1	7.3	5.9	4.8	3.7	2.6	1.7	1.3
5 mil	13.8	11.1	8.9	7.2	5.6	4.0	2.6	1.9		13.8	11.1	8.9	7.2	5.6	4.0	2.6	1.9
7.5 mil	20.7	16.6	13.4	10.8	8.4	6.0	3.8	2.9		20.7	16.6	13.4	10.8	8.4	6.0	3.8	2.9
10 mil	27.6	22.1	17.8	14.4	11.2	8.0	5.1	3.9		27.6	22.1	17.8	14.4	11.2	8.0	5.1	3.9
15 mil	41.3	33.2	26.8	21.6	16.8	12.0	7.7	5.8		41.3	33.2	26.8	21.6	16.8	12.0	7.7	5.8
20 mil	55.1	44.2	35.7	28.8	22.4	15.9	10.2	7.7		55.1	44.2	35.7	28.8	22.4	15.9	10.2	7.7
30 mil	82.7	66.4	53.5	43.2	33.7	23.9	15.3	11.6		82.7	66.4	53.5	43.2	33.7	23.9	15.3	11.6
40 mil	110.2	88.5	71.4	57.6	44.9	31.9	20.5	15.4		110.2	88.5	71.4	57.6	44.9	31.9	20.5	15.4



# Ratings and Specifications

V330-F		V330-F□□□□03M-□□□	V330-F□□□□12M-□□□	V330-F□□□□50C-□□□
Symbolologies *1	1D Symbolologies	Code 39, Code 128, BC412, Interleaved 2 of 5, UPC/EAN, Codabar, Code 93, Pharmacode, PLANET, Postnet, Japanese Post, Australian Post, Royal Mail, Intelligent Mail, KIX		
	2D Symbolologies	Data Matrix (ECC 0-200), QR Code, Micro QR Code, Aztec Code, DotCode		
	Stacked Symbolologies	PDF417, MicroPDF417, GS1 Databar (Composite and Stacked)		
Reading Performance *2	Number of Reading Digits	No Upper Limit (depending on bar width and reading distance)		
	Aiming Light	Two Blue LEDs		
	Illumination	Inner LEDs: Four White and Four Red (Wavelength: 625 nm)		
		Outer LEDs:	None	Outer LEDs:
	Reading Distance / Field of View	Refer to <i>Field of View Charts</i> for details.		
	Pitch Angle ( $\alpha$ ) *3	$\pm 30^\circ$		
	Skew Angle ( $\beta$ ) *3	$\pm 30^\circ$		
	Tilt Angle ( $\gamma$ ) *3	$\pm 180^\circ$		
Image Capture	Focus	Fixed Focus (Wide = 5.2 mm, Medium = 7.7 mm, Narrow = 16 mm)		
	Resolution	752 (H) x 480 (V)	1280 (H) x 960 (V)	2592 (H) x 1944 (V)
	Color / Monochrome	Monochrome CMOS	Monochrome CMOS	Color CMOS
	Shutter	Global Shutter	Global Shutter	Rolling Shutter
	Frames per Second	60 fps	42 fps	5 fps
	Exposure	50 to 100,000 $\mu$ s		
Image Logging	FTP			
Trigger	Communication Trigger (Ethernet)			
I/O Specifications	Input Signals	Ethernet		
	Output Signals	Ethernet		
Communication	Connectivity	Ethernet TCP/IP, EtherNet/IP, PROFINET		
	Ethernet Specifications	100BASE-TX / 10BASE-T		
Indicator LEDs	PASS (Green), PWR (Green)			
Power Supply Voltage	Source: 44-57 VDC IEEE802.3af POE			
Current Consumption	Max Current: 0.10A			
Environmental Immunity *4	Ambient Temperature Range	Operating: 0 to 40° C Storage: -50 to 75° C (No Icing or Condensation)		
	Ambient Humidity Range	Operating and Storage: 5% to 95% (Non-Condensing)		
	Ambient Atmosphere	No Corrosive Gases		
	Vibration Resistance (Destructive)	Oscillation Frequency: 10 to 150Hz, Half Amplitude: 0.35 mm, Vibration Direction: X/Y/Z, Sweep Time: 8 minute/count, Sweep Count: 10 times		
	Shock Resistance (Destructive)	Impact Force: 150 m/s <sup>2</sup> , Test Direction: 6 directions, three times each (up/down, front/back, left/right)		
	Degree of Protection	IEC 60529 IP40		
Weight	Main Body Only	72 g		
	Packaging Weight	Approx. 180 g (including packing)		
Dimensions	Main Body Dimensions	40 (W) x 63 (D) x 24 (H) mm		
	Packaging Dimensions	170 (W) x 117 (D) x 86 (H) mm		
Accessories	ReadMeFirst, CE Compliance Sheet			
LED Safety Standard	IEC 62471-1: 2006 Risk-Exempt Group			
Safety Standards	EN 55024:2010, EN 55032:2015 + AC:2016 FCC Part 15, Subpart B (Class B) UL60950-1 BIS, RCM, KC, EAC, BSMI			
Materials	Case	Aluminum Diecast, Alumite (Black)		
	Reading Window	Acrylic		
Software	WebLink			

\*1. These symbolologies are supported based on Omron's read capability validation standard. Omron recommends that validation be performed for each application.

\*2. Unless otherwise specified, reading performance is defined with center of field of view, angle  $R = \infty$ .

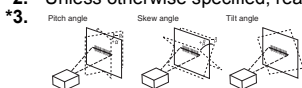

\*4. In an electrically noisy environment, use only the V430-F in combination with a noise filter cable (V430-W□F-□M) to ensure proper operation.

# Dimensions

(Unit: mm)

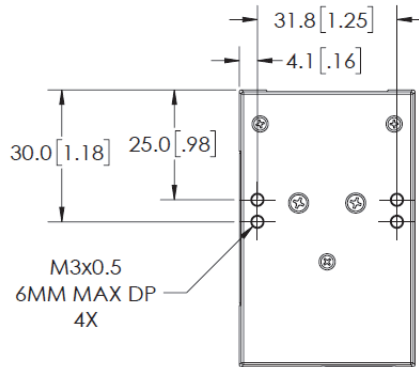
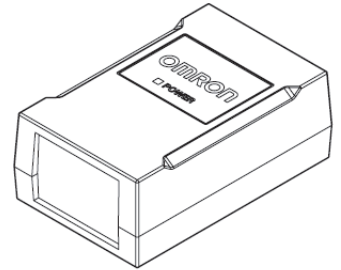
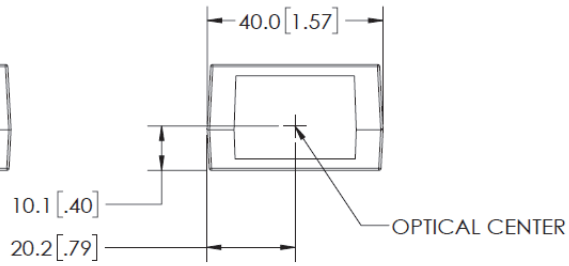
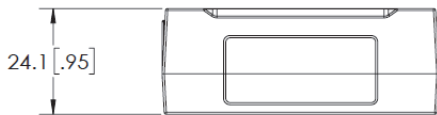
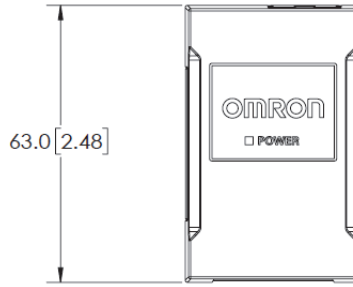

## Diffuser Kit – Peel and Stick Accessory. Exterior to unit. V330-AF1

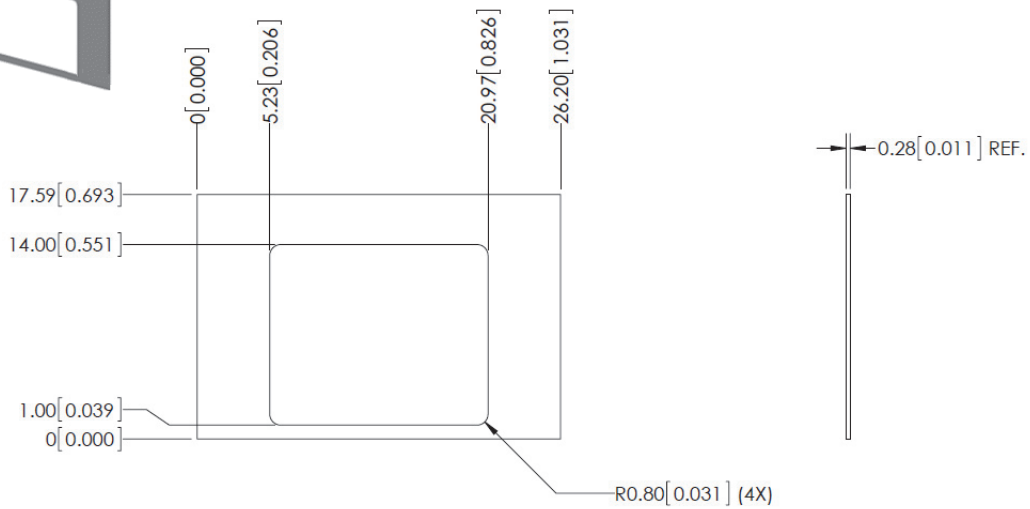

**Polarizer Kit – Peel and Stick Accessory. Exterior to unit.**  
**V330-AF2**

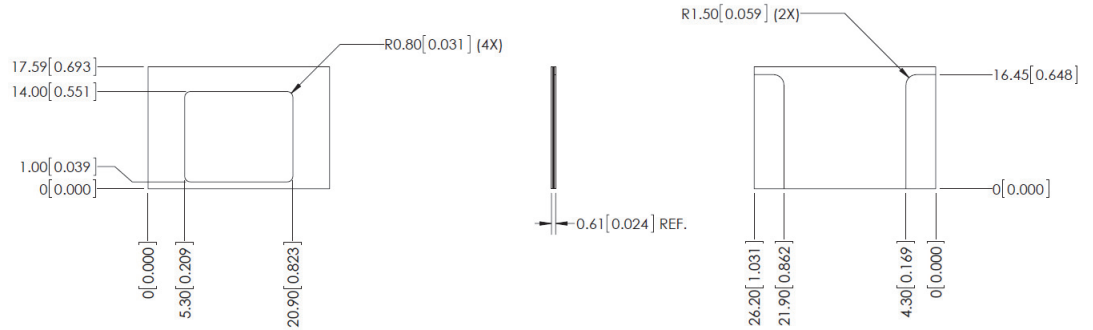
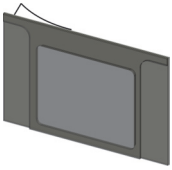

**Standard Ethernet Cables, In-Cabinet Use; Standard RJ45 Connectors on Both Ends; Green**

- XS6W-5PUR8SS100CM-G
- XS6W-5PUR8SS300CM-G
- XS6W-5PUR8SS500CM-G
- XS6W-5PUR8SS1000CM-G
- XS6W-5PUR8SS1500CM-G

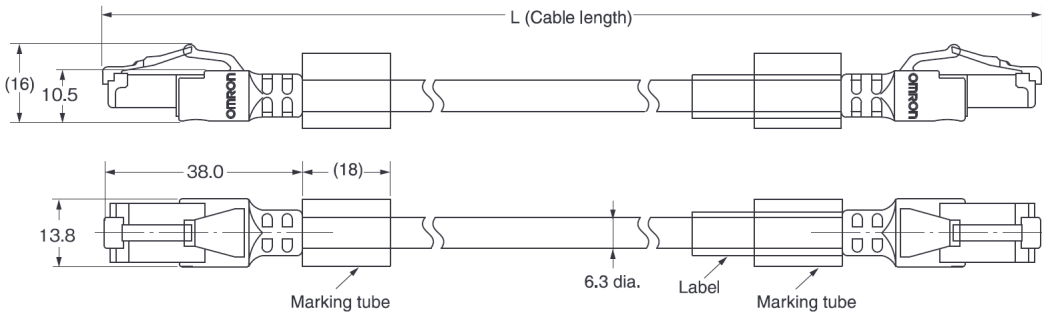

**Standard Ethernet Cables, Out-of-Cabinet Use; Rugged RJ45 Connectors on Both Ends; Light Blue**

- XS5W-T421-CMD-K
- XS5W-T421-EMD-K
- XS5W-T421-GMD-K
- XS5W-T421-JMD-K
- XS5W-T421-KMD-K

**High Flex Ethernet Cables for Robot and Cable Tray Use; Rugged RJ45 Connectors on Both Ends; Light Blue**

- XS5W-T421-CMD-KR
- XS5W-T421-EMD-KR
- XS5W-T421-GMD-KR
- XS5W-T421-JMD-KR
- XS5W-T421-KMD-KR

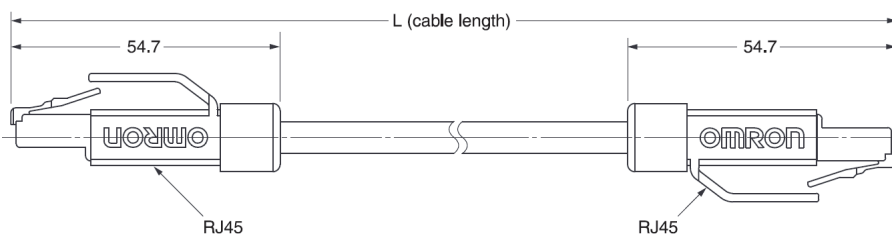

## V330-F

### Related Manuals

---

Man.No.	Model	Manual
Z432 (84-9000400-02)	V320-F, V330-F, V420-F, V430-F	MicroHAWK V320-F / V330-F / V420-F / V430-F User Manual

**OMRON AUTOMATION AMERICAS HEADQUARTERS** • Chicago, IL USA • 847.843.7900 • 800.556.6766 • automation.omron.com

**OMRON CANADA, INC. • HEAD OFFICE**

Toronto, ON, Canada • 416.286.6465 • 866.986.6766 • automation.omron.com

**OMRON ELECTRONICS DE MEXICO • HEAD OFFICE**

Ciudad de México • 52.55.5901.4300 • 01.800.386.6766 • mela@omron.com

**OMRON ELECTRONICS DE MEXICO • SALES OFFICE**

San Pedro Garza García, N.L. • 81.12.53.7392 • 01.800.386.6766 • mela@omron.com

**OMRON ELECTRONICS DE MEXICO • SALES OFFICE**

Eugenio Garza Sada, León, Gto • 01.800.386.6766 • mela@omron.com

**OMRON ELETRÔNICA DO BRASIL LTDA • HEAD OFFICE**

São Paulo, SP, Brasil • 55 11 5171-8920 • automation.omron.com

**OMRON ARGENTINA • SALES OFFICE**

Buenos Aires, Argentina • +54.11.4521.8630 • +54.11.4523.8483  
mela@omron.com

**OTHER OMRON LATIN AMERICA SALES**

+54.11.4521.8630 • +54.11.4523.8483 • mela@omron.com

*Authorized Distributor:*

**Controllers & I/O**

- Machine Automation Controllers (MAC) • Motion Controllers
- Programmable Logic Controllers (PLC) • Temperature Controllers • Remote I/O

**Robotics**

- Industrial Robots • Mobile Robots

**Operator Interfaces**

- Human Machine Interface (HMI)

**Motion & Drives**

- Machine Automation Controllers (MAC) • Motion Controllers • Servo Systems
- Frequency Inverters

**Vision, Measurement & Identification**

- Vision Sensors & Systems • Measurement Sensors • Auto Identification Systems

**Sensing**

- Photoelectric Sensors • Fiber-Optic Sensors • Proximity Sensors
- Rotary Encoders • Ultrasonic Sensors

**Safety**

- Safety Light Curtains • Safety Laser Scanners • Programmable Safety Systems
- Safety Mats and Edges • Safety Door Switches • Emergency Stop Devices
- Safety Switches & Operator Controls • Safety Monitoring/Force-guided Relays

**Control Components**

- Power Supplies • Timers • Counters • Programmable Relays
- Digital Panel Meters • Monitoring Products

**Switches & Relays**

- Limit Switches • Pushbutton Switches • Electromechanical Relays
- Solid State Relays

**Software**

- Programming & Configuration • Runtime