

UNCONTROLLED DOCUMENT

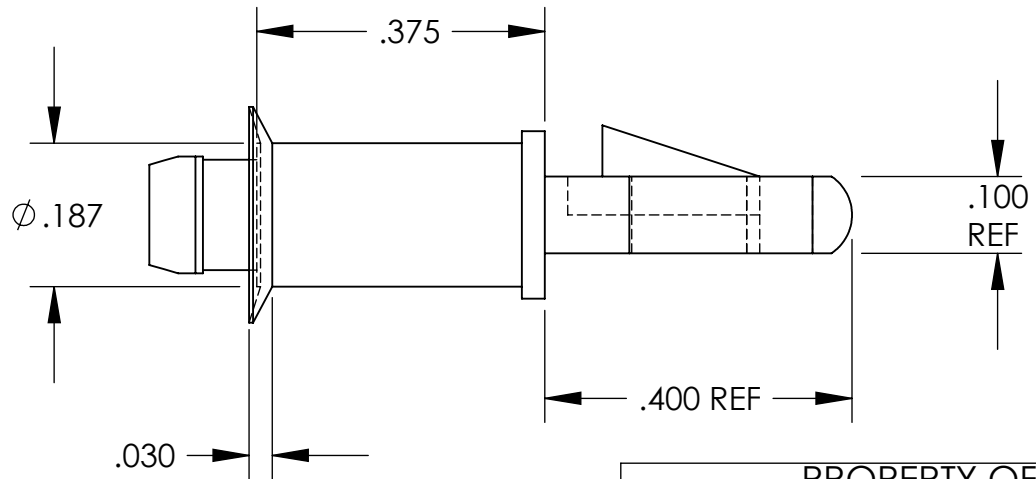
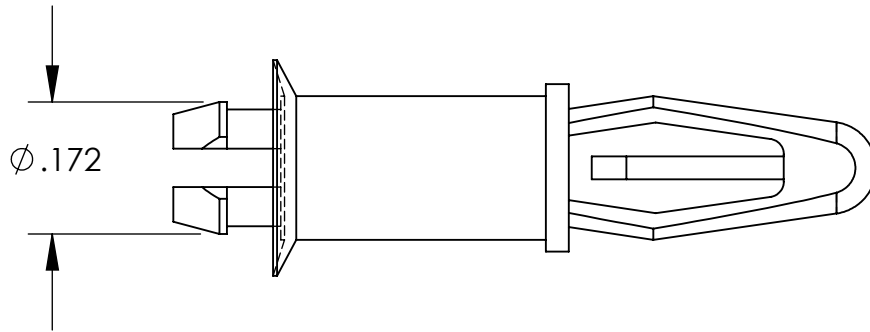
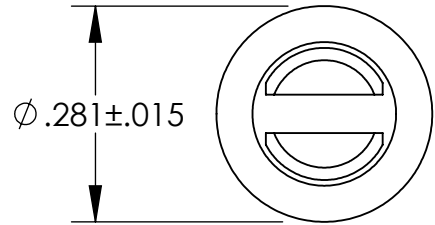

NOTES:
 SPRING END FITS $\phi .156$ HOLE
 LOCK OR TENSION END FITS $\phi .156$ HOLE
 PANEL THICKNESS $.062 \pm .015$

TOLERANCES UNLESS NOTED

- $\pm .005$ ON DIMENSIONS THRU $.625$
- $\pm .008$ ON DIMENSIONS $.626$ THRU 1.000
- $\pm .010$ ON DIMENSIONS 1.001 THRU 1.500
- $\pm .015$ ON DIMENSIONS LARGER THAN 1.500
- $\pm .015$ ON FRACTIONAL DIMENSIONS

WE RESERVE THE RIGHT
 TO DISCONTINUE ITEMS,
 CHANGE SPECIFICATIONS
 OR DESIGN AT ANY TIME
 WITHOUT NOTICE AND
 WITHOUT INCURRING
 ANY OBLIGATIONS

PROPERTY OF		
MICRO PLASTICS INC.		
CATALOG DRAWING PCB SUPPORT "LCSP" SERIES MICRO P/N 27LCSP00375 DWG. # 27LCSP00375 FILE SERVER\ENG\WEB		
MATERIAL:		6/6 NYLON
DATE	SCALE	DSB
	4:1	