

Horns and Sirens / Heavy-Duty multi-tone sounder

Multi-t.sounder WM 32 tne 9-60VDC RD

Part No.: 141.000.55

**MECHANICAL DATA**

Length	132 mm
Width	165 mm
Height	136 mm
Materials	PC/ABS
Housing colour	Red
Protection category	IP66
Connection	Screw terminals
cross-sectional area maximum	2,50mm ² / 14AWG
Cable entry	Screwed cable gland
Cable entry minimum	d = 8 mm
Cable entry maximum	d = 12 mm
Tension relief	Present (conforms to VDE)
Type of fixing	Wall mounting
Working temperature minimum	-25°C
Working temperature maximum	+70°C
Weight with packaging	598 g
Product weight	515 g

ELECTRICAL DATA

Operating voltage	9-60V
Operating voltage type	DC
Operating voltage tolerance	+/- 0%
Rated operational voltage	24 VDC
Rated operational current	120 mA
Protection class	Protection class 2
Pollution degree	3

OPTICAL DATA

Service life optical	5,000 h minimum
----------------------	-----------------

ACUSTICAL DATA

Volume (max) at 1m distance	110,0 dB (A)
Acoustic signal image	Multi-tone
Number of tones	32 tone
Acoustic service life	5,000 h minimum

APPROVAL DATA

Conforms with CE	Yes
WEEE	No
Conform with ATEX-directive	No



For additional installation and mounting information, refer to the appropriate user guide at www.werma.com. This printed copy is for information only and is subject to alteration.

Horns and Sirens / Heavy-Duty multi-tone sounder
Multi-t.sounder WM 32 tne 9-60VDC RD

Conforms with CCC	No
Conforms with UL	No
Conforms with FCC	No
Conforms with IC	No
EAC certificate available	Yes
Conforms with AS-I	No
ICAO Certification	No
Conforms with GL	No
Conforms with RoHS CN	No
Conforms with VdS	No

DRAWING

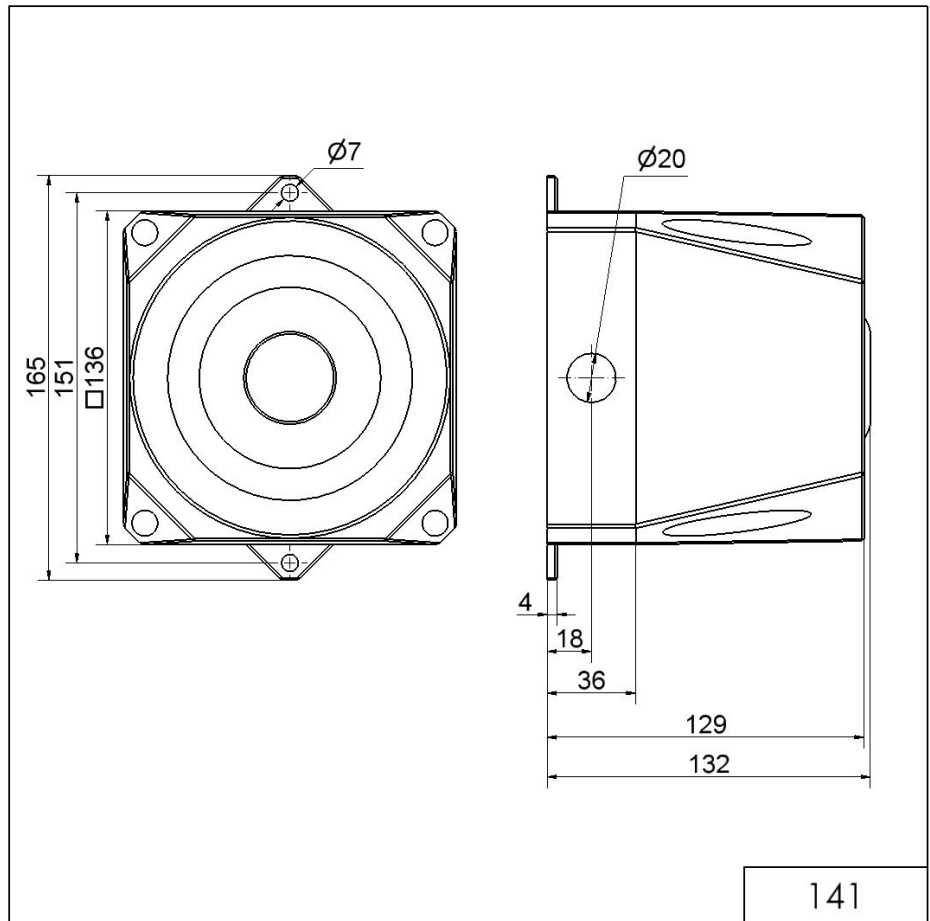

! For additional installation and mounting information, refer to the appropriate user guide at www.werma.com. This printed copy is for information only and is subject to alteration.